

English

# AVANT<sup>®</sup>

## Loaders and attachments



# Foreword

This catalogue contains most of the Avant loaders and attachments available from Avant Tecno Oy at the date of printing.

Avant has a policy of continuing product development and retains the right to change specifications without notice.

All attachments listed in this catalogue may not be available on all markets and in all countries - please consult your local Avant distributor.

Operation of certain attachments may require specific equipment on the loader. Please consult your local Avant distributor.

Compatibility tables between attachments and loader models are advisory. All attachments do not fit on all loader models. Please contact your local Avant distributor to make sure that the attachment is compatible with your Avant loader.

Avant 200 series 2 (Avant 220, 225 and 225LPG), which came to the market in January 2016, has the same attachment bracket and multi connector for hydraulic hoses as other Avant loader models (300, 400, 500, 600, 700, 800, R and e series). However, the attachment bracket of the earlier 200 series 1 (Avant 216/218/220, manufactured in 2004-2015) is different from other models. Therefore 200 series 1 attachments do not fit on Avant 200 series 2, 300, 400, 500, 600, 700, 800, R and e series, and vice versa.



# Table of Contents

<b>Foreword</b> .....	2	Work light kit, on cab LX.....	34
<b>Table of Contents</b> .....	3	Road traffic light kit.....	35
<b>Loaders and options</b> .....	<b>6-21</b>	Beacon.....	35
200 series.....	6	Beacon light bar.....	35
400 series.....	8	Cab L.....	36
500 series.....	10	Rear wall.....	36
600 series.....	12	Cab LX.....	36
700 series.....	14	Cab DLX.....	37
800 series.....	16	Cab GT.....	37
R series.....	18	HD cover plates.....	38
e series.....	20	Snow chains.....	38
<b>Options</b> .....	<b>22-45</b>	Mudguards rear.....	39
Tire options, on a new machine.....	22	Suspension seat.....	39
Telescopic boom.....	25	Full suspension seat.....	39
Boom self levelling.....	25	Engine heater.....	40
Boom floating, machine without self levelling.....	25	Exhaust purifier.....	40
Boom floating, machine with self levelling.....	26	Hand drive controls.....	40
Smooth drive (boom suspension).....	26	Rear carrier.....	41
Hydraulic attachment coupling plate.....	26	Reverse beeper.....	41
Joystick 6 functions.....	27	Tie down bracket on wheel hub.....	41
Joystick 8 functions.....	27	Tie down bracket in the rear/on the sides...	42
Opticontrol.....	27	Lifting kit, for machines with ROPS frame..	42
Control switch pack for rear mounted attachments..	28	Lifting kit, for machines with cab LX/DLX..	42
Adapter cable for attachment control switch pack..	28	Weather cover.....	43
Auxiliary hydraulics outlet in the rear, single acting..	28	Transport cover.....	43
Auxiliary hydraulics outlet in the rear, double acting..	29	Loading ramps.....	43
Second auxiliary hydraulics outlet in the front..	29	Battery charger 12V.....	44
Drive release valve.....	29	Adapter cable 12V.....	44
Anti slip valve.....	30	Adapter plug 12V.....	44
Back weight.....	30	Battery pack e5.....	45
Rear side weights 80 kg.....	30	Rapid battery charger, e6.....	45
Rear side weights 180 kg.....	31		
Wheel weight.....	31		
Light rear bumper.....	31		
Attachment coupling plate in the rear.....	32		
Hydraulic rear lift.....	32		
Trailer coupling.....	33		
Rear guard.....	33		
Tool box.....	33		
Work light kit, on ROPS frame.....	34		

# Table of Contents

## ATTACHMENTS

<b>Buckets, material handling.....46-64</b>	Vacuum brush.....82
General bucket.....46	Leguan 50 access platform.....83
Heavy duty general bucket.....47	Tipping trailer.....84
Light material bucket.....48	<b>Groundcare.....85-98</b>
XL Light material bucket.....49	Lawn mower 1200.....85
4 in 1 bucket.....50	Lawn mower 1500.....86
High tip bucket.....51	Collecting lawn mower 1200.....87
XL high tip bucket.....52	Collecting lawn mower 1500.....88
Grapple bucket.....53	Cutting bar.....89
Demolition grapple bucket.....54	Flail mower.....90
Root grapple.....55	Flail mower with hydraulic side arm S30..91
Levelling bucket.....56	Hydraulic side arm S30.....92
Pallet fork.....57	Mechanical side arm S30.....92
Pallet fork with side shift.....58	Flail mower S30.....93
Skip bucket.....59	Cutting bar S30.....93
Jib boom.....60	Rotary hedge cutter S30.....94
Telescoping jib boom.....61	Multi function drive unit S30.....95
Hydraulic trailer hitch.....62	Edge trimmer.....96
Ball hitch on front.....62	Lawn aerator.....97
Beehive mover.....63	Weed brush.....98
Site toolbox.....64	<b>Landscaping.....99-112</b>
<b>Property maintenance.....65-84</b>	Rotary hoe series 2.....99
Dozer blade 1400.....65	Power rake.....100
Dozer blade 2000/2500.....66	Rotary harrow.....101
Snow plow.....67	Leveller.....102
Flipper bucket.....68	Leveller HD.....103
Zoom snow plow.....69	Roller compactor.....104
Ice rink scraper blade.....70	Front rake.....105
Snow blower.....71	Ripper.....106
Rotary broom.....72	Mulcher CRI400.....107
Collecting broom 1100.....73	Screening bucket.....108
Collecting broom 1500.....74	Stump grinder.....109
Bucket broom.....75	Mounting kit for stone installation clamp..110
High pressure washer.....76	Stone grab.....111
Artificial turf attachment.....77	Grabbing tool.....112
Artificial turf maintenance brush.....78	
Sand/salt spreader.....79	
Centrifugal sand/salt spreader.....80	
Towable sand spreader.....81	

# Table of Contents

<b>Digging and construction.....</b>	<b>113-130</b>	Horse arena harrow.....	151
Backhoe 170.....	113	Big bag transporter.....	152
Backhoe 210.....	114	Stone collecting bucket.....	153
Backhoe 260.....	115	<b>Power Packs.....</b>	<b>154-155</b>
Backhoe 260 with remote control.....	116	Generator.....	154
Mini digger.....	117	Compressor.....	154
Auger.....	118	Pressure washer.....	155
Trencher.....	119	<b>Forestry.....</b>	<b>156-164</b>
Multi function drive unit.....	120	Winch.....	156
Hydraulic breaker.....	122	Tree shear.....	157
Tarbox.....	123	Log grab, heavy duty.....	158
Asphalt spreader.....	124	Log grab.....	159
Asphalt grinder.....	125	Timber grab.....	160
Concrete mixing bucket.....	126	Timber grab HD.....	161
Drum type concrete mixer.....	127	Log cutter/splitter.....	162
Vibrating plate.....	128	Wood chipper CH100.....	163
Disc scraper.....	129	Wood chipper CH180.....	164
Submersible pump.....	130	<b>Options.....</b>	<b>165-170</b>
<b>Farming and horse stables.....</b>	<b>130-153</b>	Tilt adapter.....	165
All-round grapple.....	130	Attachment rotator.....	165
Silage fork.....	131	Hydraulic side shift adapter.....	166
XL silage grab.....	132	Side shift adapter.....	166
Silage dozer blade.....	133	Adapter plate, weld-on.....	167
Feeding table cleaning blade.....	134	Disclaimer for Avant adapters.....	167
Silage dispenser.....	135	Euro adapter.....	167
Feed mover screw.....	136	Skid steer adapter.....	168
Silage block cutter.....	137	Drawbar.....	168
Carousel broom.....	138	Hydraulic manifolds to attachment multi connector..	169
Round bale grab.....	139	Adapters for mounting 200 series attachments..	170
Bale handler.....	140	<b>Filter kits.....</b>	<b>171</b>
Bale fork.....	141	<b>Wheels &amp; tyres.....</b>	<b>172</b>
Round bale splitter.....	142	<b>Avant Shop.....</b>	<b>174</b>
Bedding distributor bucket.....	143	<b>Multi Connector System.....</b>	<b>176</b>
Manure fork.....	144		
Grain/flour dispenser bucket.....	144		
Grain/flour dispenser bucket XL.....	145		
Push broom.....	146		
3 point hitch adapter.....	147		
Slurry mixer.....	148		
Horse manure collector.....	149		
Front cultivator.....	150		

# AVANT<sup>®</sup> 200

200 series



Model	AVANT 220	AVANT 225
Engine	Kohler CV640 Stage V	Kohler ECV730 EFI Stage V
Function	4-stroke	4-stroke
Fuel	gasoline	gasoline
Engine output (ECE R120)	14,9 kW (20 hp)	18,6 kW (25 hp)
Auxiliary hydraulics		
• Front outlet (standard)	30 l/min	42 l/min
• Rear outlet (optional)	7 l/min	7 l/min
Max. drive speed	10 km/h	10 km/h
Wheels	20x8.00-10 tractor/grass	20x8.00-10 tractor/grass
Pulling force	620 daN	640 daN
Tipping load *)	350 kg	350 kg
Lifting height	1400 mm	1400 mm
Weight	700 kg	700 kg
Height	1880 mm	1880 mm
Width	995/1025 mm	995/1025 mm
Length	1910 mm	1910 mm
<b>Product no:</b>	<b>A21675</b>	<b>A21687</b>



## Avant 200 series

- Avant quick attach system for attachments (same as on other Avant models)
- Multi connector for hydraulic attachments (same as on other Avant models)
- Spacious cockpit: good legroom and storage space
- Multi function display: hour meter and fuel gauge, engine indicators, road traffic light indicators
- 14 l fuel tank
- Hydraulic oil cooler
- 47 Ah battery
- LED front lights (1000 lumen)
- Avant 225 with 25 hp electronic fuel injection gasoline engine starts easily in any situation, no choke needed
- Auxiliary hydraulics oil flow to hydraulically driven attachments as high as 42 l/min

## Options

- Suspension seat with arm rests and heater
- Joystick 6 functions: auxiliary hydraulics control with buttons on joystick

- Cab L: windscreen with wiper and washer, right side and rear windows – door also available as an option
- Anti slip valve
- LED work light kit: 2 front, 1 rear
- Road traffic kit
- Auxiliary hydraulics outlet in the rear
- Opticontrol attachment control system for attachments with electric and hydraulic functions
- Wheel weights

## Safety

- Longer wheelbase and lower center of gravity – better stability
- Certified ROPS safety frame and FOPS canopy
- Seat belt
- LED front lights as standard, extra LED work light kit (2 front, 1 rear, 700 lumen) available as an option
- Excellent, unrestricted field of vision to the attachment and working environment

**Avant 200 series - power and operator comfort  
for both do-it-yourself and professional use**

# AVANT<sup>®</sup> 400

400 series



## Width

Wheel size	Profile	Machine width
5.70-12	TR	930 mm
23 x 8.50 - 12	TR or grass	1050 mm
23 x 10.50 - 12	TR or grass	1090 mm

Model	AVANT 423
Length	2195 mm
Width (23x8.50-12 wheels)	1050 mm
Height	1980 mm
Weight	1030-1080 kg
Standard wheels	23x8.50-12" grass/TR
Transmission, drive	Hydrostatic
Pulling force	700 kp
Drive speed max.	12 km/h
Auxiliary hydraulics oil flow / pressure	34 l/min 185 bar
Hydraulic oil cooler	Standard
Turning radius	880 / 1970 mm
Max. lifting height (with telescopic boom)	2750 mm
Tipping load	550 kg
Engine make and type	Kubota D902 Stage V
Engine output (ECE R120)	16 kW (22 hp)
Maximum torque	56 Nm @ 2600 rpm
Fuel	Diesel
<b>Product no:</b>	<b>A424315</b>





## Avant 423

- Equipped with Kubota 22 hp diesel engine – more horsepower and torque especially on low revs
- Auxiliary hydraulics oil flow 34 l/min

## Standard specification

- Multi connector system for hydraulic attachments
- Hydraulic oil cooler
- Certified ROPS safety frame + FOPS canopy
- 2 front LED work lights (1000 lumen)
- Hydrostatic 4WD
- Standard tyres 23x8.50-12 Traction or Grass profile
- Standard 'Avant Green' seat with seat belt
- 20 l fuel tank

## Options

- Telescopic boom
- Suspension seat with arm rests and heater
- Joystick 6 functions: auxiliary hydraulics control with buttons on joystick
- Cab L: windscreen with wiper and washer, right side and rear
- Anti slip valve
- LED work light kit: 2 front, 1 rear
- Road traffic kit
- Auxiliary hydraulics outlet in the rear
- Opticontrol attachment control system for attachments with electric and hydraulic functions
- Extra counterweights

**Strong and handy machine**

# AVANT<sup>®</sup> 500

500 series



## Height with Cab

Wheel size	26x12.00-12 or 320/60-12*	27x8.50-15
Cab L	2035 mm	2048 mm
Cab LX	2025 mm	2038 mm
Cab DLX	2045 mm	2058 mm

\*) With 23" wheels machine is 15 mm lower

## Width

Wheel size	Profile	Machine width
27 x 8.50 - 15*	TR	1030 mm
23 x 8.50 - 12	TR or grass	1080 mm
23 x 10.50 - 12	TR or grass	1130 mm
26 x 12.00 - 12*	TR or grass	1290 mm
320/60-12 HD*	TR	1290 mm
26.5 x 14.00 - 12**	grass	1420 mm

\*) Bigger wheels will increase total machine height by 20-35 mm

\*\*\*) Requires 40 mm spacers on the wheel hubs

Model	AVANT 523	AVANT 528	AVANT 530
Length	2450 mm	2570 mm	2570 mm
Width (with standard wheels)	1130 mm	1130 mm	1130 mm
Height (with standard wheels)	1985 mm	1985 mm	1985 mm
Weight	1200 + 170 kg	1250 + 170 kg	1290 + 170 kg
Standard wheels	23x10.50-12" grass/TR		
Transmission, drive	hydrostatic Avant Optidrive™	hydrostatic Avant Optidrive™	hydrostatic Avant Optidrive™
Pulling force	900 kp	950 kp	1050 kp
Drive speed max.	12 km/h	12 km/h	19 km/h
Auxiliary hydraulics oil flow / pressure	34 l/min 185 bar	36 l/min 200 bar	36 l/min 200 bar
Hydraulic oil cooler	Standard	Standard	Standard
Turning radius inside/outside	995 / 2050 mm	995 / 2050 mm	995 / 2050 mm
Max. lifting height	2790 mm	2790 mm	2790 mm
Tipping load	800 kg	950 kg	950 kg
Max. breakout force / 50 cm	1100 kg	1250 kg	1250 kg
Engine make and type	Kubota D902 Stage V	Kubota D1105 Stage V	Kubota D1105 Stage V
Engine output (ECE R120)	16 kW (22 hp)	19 kW (26 hp)	19 kW (26 hp)
Maximum torque	56 Nm @ 2600 rpm	72 Nm @ 2200 rpm	72 Nm @ 2200 rpm
Fuel	Diesel	Diesel	Diesel
<b>Product no:</b>	<b>A21741</b>	<b>A424277</b>	<b>A424278</b>

# AVANT<sup>®</sup> 500



500 series

## Avant 523

- Equipped with Kubota 22 hp diesel engine – more horsepower and torque especially on low revs
- Auxiliary hydraulics oil flow 34 l/min

## Avant 530

- Two drive speed areas (2-speed Poclair drive motors), max. drive speed 19 km/h
- Otherwise like Avant 528

## Standard specification

- Strong piston type Poclair drive motors
- Telescopic boom
- **OPTIBRIVE™** drive system - more power to drive and to attachment hydraulics
- Multi connector system for hydraulic attachments
- Hydraulic oil cooler
- Certified ROPS safety frame + FOPS canopy
- 2 front LED work lights (1000 lumen)
- Hydrostatic 4WD
- Standard tyres 23x10.50-12 Traction or Grass profile
- Suspended Heated 'Avant Green' Seat with seat belt & hand rests
- Integrated back weight 170kg
- All Avant loaders with combustion engine comply with the European Stage V emission standard

**Excellent choice with robust  
and simple hydraulics**

# AVANT<sup>®</sup> 600

600 series



## Height with Cab

Wheel size	26x12.00-12 or 320/60-12*	27x8.50-15
Cab L	2035 mm	2048 mm
Cab LX	2025 mm	2038 mm
Cab DLX	2045 mm	2058 mm
Cab DLX with Air conditioning on the roof	2181 mm	2194 mm

\*) With 23" wheels machine is 15 mm lower

## Width

Wheel size	Profile	Machine width
27 x 8.50 - 15*	TR	1030 mm
23 x 8.50 - 12	TR or grass	1080 mm
23 x 10.50 - 12	TR or grass	1130 mm
26 x 12.00 - 12	TR or grass	1290 mm
320/60-12 HD	TR	1290 mm
26.5 x 14.00 - 12**	grass	1420 mm

\*) Bigger wheels will increase total machine height by 13 mm

\*\*) Requires 40 mm spacers on the wheel hubs

Model	AVANT 630	AVANT 635	AVANT 640
Length	2570 mm	2570 mm	2570 mm
Width (standard wheels)	1290 mm	1290 mm	1290 mm
Height	2035 mm	2035 mm	2035 mm
Weight	1330 + 170 kg	1360 + 170 kg	1420 + 170 kg
Standard wheels	26x12.00-12"Grass / TR	26x12.00-12"Grass / TR	26x12.00-12"Grass / TR
Transmission, drive	hydrostatic Avant Optidrive™	hydrostatic Avant Optidrive™	hydrostatic Avant Optidrive™
Pulling force max.	1200 kp	1200 kp	1400 kp
Drive speed max.	14 km/h	14 km/h	11/20 km/h (2 speed)
Auxiliary hydraulics oil flow / pressure	44 l/min 200 bar	50 l/min 200 bar	50 l/min 200 bar
Turning radius inside/outside	900 / 2190 mm	900 / 2190 mm	900 / 2190 mm
Max. lifting height	2835 mm	2835 mm	2835 mm
Tipping load	1100 kg	1100 kg	1100 kg
Max. breakout force / 50 cm	1250 kg	1250 kg	1250 kg
Engine make and type	Kubota D1105 Stage V, 3-cyl.	Kubota V1505 Stage V, 4-cyl.	Kubota V1505 Stage V, 4-cyl.
Engine output (ECE R120)	19 kW (26 hp)	19 kW (26 hp)	19 kW (26 hp)
Maximum torque	72 Nm @ 2200 rpm	93 Nm @ 1700 rpm	93 Nm @ 1700 rpm
Fuel	Diesel	Diesel	Diesel
<b>Product no:</b>	<b>A424286</b>	<b>A433088</b>	<b>A433089</b>



### Avant 600 series with EU Stage V engines

- All Avant loaders with combustion engine comply with the European Stage V emission standard
- 600 series with 19 kW engine output doesn't need diesel particulate filter DPF

### Avant 600 series benefits over 500 series

- Stronger and faster hydraulic system for professionals
- 8 function joystick available (operation of telescopic boom and auxiliary hydraulics with buttons on joystick)
- More oil flow for attachments, double pump with 44 l/min (630) / 50L/min (635, 640)
- More handling power
- LX Cab with heater and DLX Cab available
- Air conditioning for DLX cab available (635 and 640)
- Air suspension seat for DLX Cab available
- Bigger wheels as standard

### Standard specification

- Telescopic boom
- **OPTIBRIVE™** drive system - more power to drive and to attachment hydraulics
- Strong piston type Poclain drive motors
- Multi connector system for hydraulic attachments
- Fast ground speed, max 20 km/h (640)
- Hydrostatic 4WD, Drive release valve, Hydraulic parking brake
- Certified ROPS safety frame + FOPS canopy
- 2 front LED work lights (1000 lumen)
- Standard tyres 26x12-12 Traction or Grass profile
- Full suspension heated seat with seat belt & hand rests
- Integrated back weight 170kg

**Excellent choice for demanding groundcare, construction and maintenance works**

# AVANT<sup>®</sup> 700

700 series



## Height with Cab

Wheel size	26x12.00-12 or 320/60-12	320-55/15*
Cab L	2060 mm	2094 mm
Cab LX (735 only)	2078 mm	2112 mm
Cab DLX	2105 mm	2139 mm
Cab DLX with Air conditioning on the roof	2241 mm	2275 mm

\*) With 400/50-15 machine is 30 mm higher

## Width

Wheel size	Profile	Machine width	
		735/755i	760i
27x8.50-15	TR	1030 mm	1080 mm
26x12.00-12	TR or grass	1295 mm	1350 mm
320/60-12 HD	TR	1295 mm	1350 mm
320/55-15	TR or grass	1305 mm	1360 mm
400/50-15	TR or grass	-	1450 mm

## New

Model	AVANT 735	AVANT 755i	AVANT 760i
Length	3060 mm	3060 mm	3060 mm
Width (with standard wheels)	1290 mm	1290 mm	1450 mm
Height (with standard wheels)	2060 mm	2060 mm	2110 mm
Weight	1800 kg	1970 kg	2100 kg
Standard wheels	320/60-12HD TR	320/60-12HD TR	400/50-15 TR
Transmission, drive	hydrostatic Avant Optidrive™	hydrostatic Avant Optidrive™	hydrostatic Avant Optidrive™
Pulling force max.	1200 kp	1330 kp	1880 kp
Drive speed max.	14 km/h	17 km/h	26 km/h
Auxiliary hydraulics	50 l/min 200 bar	80 l/min 225 bar	80 l/min 225 bar
Turning radius inside/outside	1240 / 2780 mm	1240 / 2780 mm	1240 / 2780 mm
Lifting height to pivot point	3080 mm	3080 mm	3100 mm
Max. lifting capacity (hydr.)	2100 kg	2100 kg	2100 kg
Max. tipping load*	1400 kg	1400 kg	1400 kg
Max. breakout force / 50 cm	1700 kg	1700 kg	1700 kg
Engine make and type	Kubota V1505 Stage V, 4-cyl.	Kohler KDI 1903 TCR Stage V	Kohler KDI 1903 TCR Stage V
Engine output (ECE R120)	19 kW (26 hp)	42 kW (57 hp)	42 kW (57 hp)
Maximum torque	93 Nm @ 1700 rpm	220 Nm @ 1500 rpm	220 Nm @ 1500 rpm
Fuel	diesel	diesel	diesel
<b>Product no:</b>	<b>A439072</b>	<b>A438150</b>	<b>A438139</b>

# AVANT<sup>®</sup> 700

700 series



## Avant 735 **New**

- Equipped with Kubota VI505 Stage V engine and same hydraulic pumps as Avant 635
- Similar lift height and lift capacity as on 755i and 760i - excellent, economical lifting and handling machine

## Avant 700 benefits over 600 series

- Outstanding handling capacity, up to 1400kg pallets
- Stronger boom construction
- More oil flow for attachments, double pump with 80 l/min (755i, 760i) or 50 l/min (735)
- More lifting height, up to 3080 mm
- Avant 755i and 760i with turbocharged common rail diesel engine comply with the EU Stage V emission regulations, equipped with diesel oxidation catalyst (DOC) and diesel particulate filter (DPF) with automatic regeneration
- Air conditioning for DLX Cab available
- Air suspension seat for DLX Cab available
- Bigger wheels as standard
- Faster travel speed
- Multi function display on 755i and 760i instead of separate gauges, with information on engine revs, working hours, fuel consumption (l/h), auxiliary hydraulics oil flow, temperatures etc.
- Large fuel tank 63 l

## Standard specification

- Telescopic boom
- **OPTIBRIVE™** drive system - more power to drive and to attachment hydraulics
- Strong piston type Poclain drive motors on all models
- Two drive speed areas on 760i
- Multi connector system for hydraulic attachments
- Joystick 8 functions
- Drive release valve
- Hydraulic parking brake
- Certified ROPS safety frame + FOPS canopy
- 2 front LED work lights (1000 lumen)
- Hydrostatic 4WD
- 5-stud wheel hub, standard tyres 320/60-12 Traction (735, 755i)
- 10-stud wheel hub, standard tyres 400/50-15 Traction (760i)
- Full suspension heated seat with seat belt & hand rests
- Integrated back weight 170kg
- Fast travel speed: 26 km/h (760i)

**Excellent compact machine with  
huge handling capacity**

# AVANT<sup>®</sup> 800

**New**

**800 series**



## Height

Wheel size	380/55 - 17 TR
ROPS	2200 mm
Cab GT	2230 mm

Model	AVANT 860i
Length	3395 mm
Width (with standard wheels)	1490 mm
Height (with standard wheels)	2200 mm
Weight	2540 kg
Standard wheels	380/55-17" TR
Transmission, drive	hydrostatic Avant Optidrive™
Pulling force max.	2100 kp
Drive speed max.	30 km/h
Auxiliary hydraulics	80 l/min 225 bar
Turning radius inside/outside	1370 mm / 2990 mm
Lifting height to pivot point	3500 mm
Max. tipping load*	1900 kg
Max. breakout force / 50 cm	2200 kg
Engine make and type	Kohler KDI 1903TCR Stage V
Engine output (ECE R120)	42 kW (57 hp)
Maximum torque	220 Nm @ 1500 rpm
Fuel	diesel
<b>Product no:</b>	<b>A436009</b>

\*) With extra counterweights



# AVANT<sup>®</sup> 800



800 series

## Avant 800 series

- Handling capacity up to 1900 kg
- Strong boom construction with two tilt cylinders
- Lifting height 3500 mm to hinge pin
- Oil flow for attachments 80 l/min (860i), twin pump
- Avant 860i with turbocharged common rail diesel engine complies with the European Stage V emission regulations, equipped with diesel oxidation catalyst (DOC) and diesel particulate filter (DPF) with automatic regeneration
- Cab with air conditioning available
- Air suspension seat for cab available
- Big 17" wheels as standard
- Avant quick attach system as standard

## Standard specification

- Telescopic boom
- Boom self levelling
- Boom floating
- **OPTIBRIVE™** drive system - more power to drive and to attachment hydraulics
- Hydrostatic 4WD
- Strong piston type Poclain drive motors on all models
- Two drive speed areas
- Multi connector system for hydraulic attachments
- Joystick 8 functions
- Drive release valve
- Hydraulic parking brake
- Certified ROPS safety frame + FOPS canopy
- 2 front LED work lights (1000 lumen)
- 10-stud wheel hub, standard tyres 380/55-17" traction
- Full suspension heated seat with seat belt & hand rests
- Integrated back weight 275 kg
- Fast travel speed: 30 km/h
- Multi function display instead of separate gauges, with information on engine revs, working hours, fuel consumption (l/h), auxiliary hydraulics oil flow, temperatures etc.
- Large fuel tank 63 l

**Biggest and strongest Avant  
with best lift capacity and lift height**



R series



## Width

Wheel size	Profile	Machine width
27 x 8.50 - 15*	TR	1030 mm
23 x 8.50 - 12	TR or grass	1080 mm
23 x 10.50 - 12	TR or grass	1130 mm
26 x 12.00 - 12*	TR or grass	1290 mm
320/60-12 HD*	TR	1290 mm

\*) Bigger wheels will increase total machine height by 20-35 mm

Model	R28	R35
Length	2570 mm	2570 mm
Width (with std tyres)	1130 mm	1290 mm
Height	2130 mm	2160 mm
Weight	1390 kg	1460 kg
Std tyre size	23x10,50-12"	26x12,00-12"
Drive transmission	hydrostatic Avant Optidrive™	hydrostatic Avant Optidrive™
Pushing power	950 kp	1100 kp
Drive speed max.	12 km/h	14 km/h
Auxiliary hydraulics	36 l/min 200 bar	50 l/min 200 bar
Hydraulic oil cooler	Standard	Standard
Turning radius inside/outside	995 / 2135 mm	898 / 2205 mm
Lifting height	2790 mm	2820 mm
Tipping load	900 kg	1050 kg
Max bucket break out force / 50 cm	1100 kg	1250 kg
Engine make and type	Kubota D1105 Stage V, 3-cyl.	Kubota V1505 Stage V, 4-cyl.
Engine output (ECE R120)	19 kW (26 hp)	19 kW (26 hp)
Maximum torque	72 Nm @ 2200 rpm	93 Nm @ 1700 rpm
Fuel	<b>Diesel</b>	<b>Diesel</b>
<b>Product number</b>	<b>A424292</b>	<b>A433090</b>



## R series

- Driver's seat in rear chassis
- Based on Avant 500/600 series: R28=528, R35=635
- Dimensions otherwise the same as 528/600, but R series is 10 cm higher
- Lift capacity with frame straight the same as 500/600 series, with max. articulation 150 kg smaller than 500/600 series
- Same turning circle as 528/600 series, when turning cockpit doesn't extend beyond turning circle of wheels
- All Avant attachments can not be mounted, backhoes for example
- Cabs not available for R series

## R series and competitors

- Shorter machine – Avant R-series is normally approx. half a meter shorter than similar horse power competitor
- Telescopic boom – Almost none of the competitors have a telescopic boom available
- Better visibility – Driver sits a lot closer to the attachment and machine is a lot more compact, allowing for a better visibility

- Better stability – Rigid articulation joint as on regular Avant design as well
- Lighter machine – Easier to transport

## Standard specification

- Telescopic Boom
- **OPTIBRIVE™** drive system - more power to drive and to attachment hydraulics
- Hydrostatic 4WD, Strong piston type Poclain drive motors
- Drive release valve, Hydraulic parking brake
- Multi connector system for hydraulic attachments
- High volume hydraulic oil cooler
- Certified ROPS safety frame + FOPS canopy
- 2 front LED work lights (1 000 lumen)
- Suspended heated 'Avant Green' seat with seat belt & hand rests

## Avant R series with EU Stage V engines

- All Avant loaders with combustion engine comply with the European Stage V emission standard
- R series with 19 kW engine output doesn't need diesel particulate filter DPF

**Strong and versatile machine with rear driver position**



e series



## Width

Wheel size	Profile	Machine width
27 x 8.50 - 15*	TR	1030 mm
23 x 8.50 - 12	TR or grass	1080 mm
23 x 10.50 - 12	TR or grass	1130 mm
26 x 12.00 - 12*	TR or grass	1290 mm
320/60-12 HD*	TR	1290 mm
	grass	1420 mm

\*) Bigger wheels will increase total machine height by 20-35 mm

\*\*) Requires 40 mm spacers on the wheel hubs

Model	AVANT e5	AVANT e6
Length	2570 mm	2570 mm
Width (with 23x10.50-12 wheels)	1130 mm	1130 mm
Height (with 23x10.50-12 wheels)	1985 mm	1985 mm
Weight	1640 kg	1400 kg
Standard wheels	23x10.50-12" TR	23x10.50-12" TR
Transmission, drive	hydrostatic Avant Optidrive™	hydrostatic Avant Optidrive™
Drive speed max.	10 km/h	10 km/h
Auxiliary hydraulics oil flow / pressure	30 l/min	30 l/min
Hydraulic oil cooler	Standard	Standard
Turning radius inside/outside	995 / 2050 mm	995 / 2050 mm
Max. lifting height	2790 mm	2790 mm
Max. lifting capacity (hydr.)	1350 kg	1350 kg
Tipping load *)	900 kg	900 kg
Max. breakout force / 50 cm	1100 kg	1100 kg
Battery type	AGM (Absorbent Glass Mat)	lithium-ion
Battery capacity	13,6 kWh	13,8 kWh
Fuel	Electric	Electric
<b>Product number</b>	<b>A433127</b>	<b>A21715</b>

\*) With extra counterweights



## Avant e5

- Battery driven, 100% full electric
- AGM (Absorbent Glass Mat) battery, maintenance free. AGM battery is a lead acid battery where the electrolyte is held in glass mats – very thin glass fibers are woven into a mat which increases surface area enough to hold sufficient electrolyte on the cells for their lifetime
- 285 Ah / 13,6 kWh battery capacity

## Avant e6

- Battery driven, 100% full electric
- First compact loader with lithium-ion battery
- 288 Ah/13,8 kWh battery capacity

- Hydrostatic 4WD, strong piston type Poclain drive motors
- **OPTIDRIVE™** drive system - more power to drive and to attachment hydraulics
- Auxiliary hydraulics oil flow max. 30 l/min
- Multi connector system for hydraulic attachments
- Hydraulic oil cooler, telescopic boom, drive release valve, hydraulic parking brake
- Suspended Heated 'Avant Green' Seat with seat belt & hand rests
- Certified ROPS safety frame + FOPS canopy
- 2 front LED work lights (1000 lumen)

### Option: rapid battery charger for Avant e6

- Two models available: 400V/16A and 400V/32A. The rapid charger reduces charging time of the lithium-ion battery considerably, compared with the built-in 230V/10A charger.

## Standard features in both models

- No exhaust emissions, very low noise, built-in battery charger

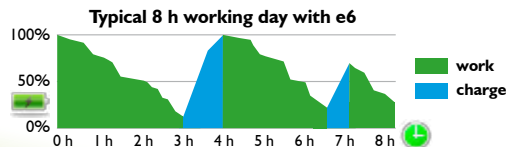
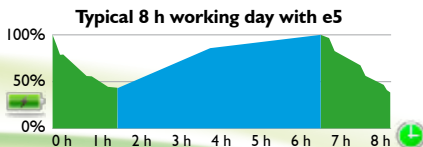

**Battery powered electric loader**

# Tire options, on a new machine

Options



## 20 x 8.00 - 10

200 series

TR

MW20810T

200 series

Grass

MW20810G

220	225	423	523	528	530	R28	R35	630	635	640	735	755i	760i	860i	e5	e6



## 5 x 10

423 manufactured until week 19/2020

TR

MW6.510T

220	225	423	523	528	530	R28	R35	630	635	640	735	755i	760i	860i	e5	e6



## 5.70-12

423 manufactured from week 20/2020

TR

MW5.5712T

220	225	423	523	528	530	R28	R35	630	635	640	735	755i	760i	860i	e5	e6



## 23 x 8.50-12

423 manufactured until week 19/2020

Grass MW6.238512G

423 manufactured from week 20/2020, 500-, 600-, R-, e-series

TR MW5.238512T

423 manufactured from week 20/2020, 500-, 600-, R-, e-series

Grass MW5.238512G

220	225	423	523	528	530	R28	R35	630	635	640	735	755i	760i	860i	e5	e6



Standard



Option



Not available

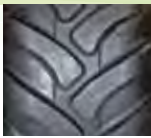

### 23 x 10.50-12

423 manufactured until week 19/2020

TR MW6.2310512T

423 manufactured until week 19/2020

Grass MW6.2310512G

423 manufactured from week 20/2020

TR MW5.2310512T

423 manufactured from week 20/2020, 500-, 600-, R-, e-series

Grass MW5.2310512G



220	225	423	523	528	530	R28	R35	630	635	640	735	755i	760i	860i	e5	e6

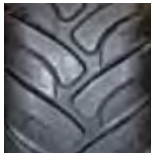

### 26 x 12.00-12

500-, 600-, R-, e-series

Grass

MW10.261212G

500-, 600-, R-, e-series

TR

MW10.261212T

735, 755i

Grass

MW10.261212G



220	225	423	523	528	530	R28	R35	630	635	640	735	755i	760i	860i	e5	e6



### 320/60 - 12 HD

500-, 600-, R-, e-series

TR

MW10.3206012T

760i

TR

MW10.3206012T

220	225	423	523	528	530	R28	R35	630	635	640	735	755i	760i	860i	e5	e6



### 27 x 8.50-15

500-, 600-, R-, e-series

TR

MW10.278515T

700 series

TR

MW10.278515T

220	225	423	523	528	530	R28	R35	630	635	640	735	755i	760i	860i	e5	e6



Standard



Option



Not available



### 26.5 x 14.00-12

500-, 600-, e series\*

Grass

MW10.2651412G

\* Requires 4 pcs A417486 40 mm spacers

Spacer kit, 4 pcs

A418958



Options

220	225	423	523	528	530	R28	R35	630	635	640	735	755i	760i	860i	e5	e6



### 320/55-15 HD

735, 755i

Grass

MW10.3205515G

735, 755i

TR

MW10.3205515T



220	225	423	523	528	530	R28	R35	630	635	640	735	755i	760i	860i	e5	e6



### 400/50-15

760i

Grass

MW10.4005015G

220	225	423	523	528	530	R28	R35	630	635	640	735	755i	760i	860i	e5	e6



### 380/55-17

860i

Grass

MW10.3805517G

860i

TR

MW10.3805517T

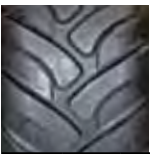

220	225	423	523	528	530	R28	R35	630	635	640	735	755i	760i	860i	e5	e6



Standard



Option



Not available



# Telescopic boom



Telescopic boom gives more outreach and lifting height, which helps loading and reaching a lot. It is also easy to adjust the distance between the front wheels and the attachment with the telescopic boom, and you can also push the loader with the teleboom if necessary. Depending on model, telescopic boom gives 400-825 mm more outreach, and the extra lifting height is 400-740 mm.

400 series                      A21359

220	225	423	523	528	530	R28	R35	630	635	640	735	755i	760i	860i	e5	e6

Options

# Boom self levelling



Self levelling system keeps the position of the attachment the same in relation to the ground, regardless of the position of the boom. Self levelling is hydraulic: there is a levelling cylinder on the left side of the boom which follows the movements of the bucket tilt cylinder and keeps the attachment level. Self levelling is disabled when boom floating is switched on.

500-, e series                      A35553  
 R28                                      A35886  
 R35                                      A35868  
 600 series                          A34144  
 700 series                          A35007

220	225	423	523	528	530	R28	R35	630	635	640	735	755i	760i	860i	e5	e6

# Boom floating, machine without self levelling



Boom floating system releases the lift cylinder so that the boom moves freely upwards from the position where it is when boom floating is switched on, allowing the attachment to follow the contours of the ground.

200 series                          A421697  
 400-700-, e series                A47773  
 R28                                      A416515  
 R35                                      A416680

220	225	423	523	528	530	R28	R35	630	635	640	735	755i	760i	860i	e5	e6

Standard     
  Option     
  Not available

# Boom floating, machine with self levelling

Options



Boom floating can also be installed on machines with boom self levelling. On 800 series boom floating is standard equipment. The boom floating valve bypasses boom self levelling, which means that boom self levelling doesn't work when boom floating is switched on.

500-700-, e series      A34015  
 R28                      A35929  
 R35                      A35930

220	225	423	523	528	530	R28	R35	630	635	640	735	755i	760i	860i	e5	e6

## Smooth drive (boom suspension)

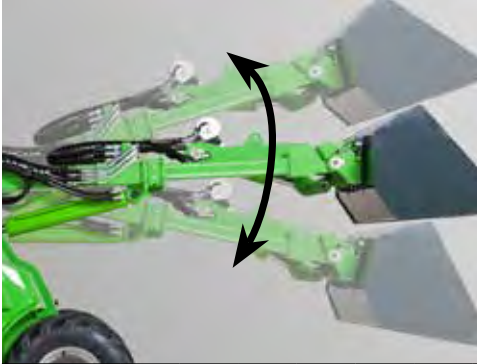

Smooth drive is a shock absorber system for the boom. When driving at high speed with a heavy load or heavy attachment the boom starts to move up and down, making driving bumpy. Smooth drive consists of an accumulator which absorbs and eliminates boom movements and makes driving considerably smoother and more stable. Smooth drive requires boom self levelling and boom floating on the loader.

500 series      A424825  
 600 series      A35830  
 700 series      A35719  
 800 series      A434866

220	225	423	523	528	530	R28	R35	630	635	640	735	755i	760i	860i	e5	e6

## Hydraulic attachment coupling plate

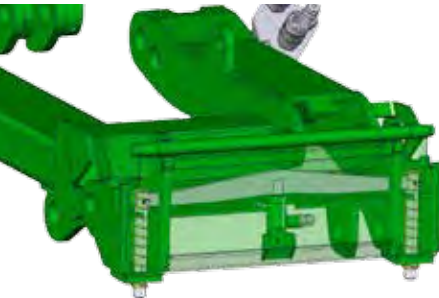

The hydraulic attachment coupling plate enables coupling and disconnecting of the attachment from driver's seat. There is a hydraulic cylinder on the attachment coupling plate which moves the locking pins up and down.

500-700-, e-, R series                      A430622  
 700 series manufactured until week 9/2020      A34956  
 700 series manufactured from week 10/2020      A430622  
 800 series                                      A434867

220	225	423	523	528	530	R28	R35	630	635	640	735	755i	760i	860i	e5	e6

Standard     
  Option     
  Not available

## Joystick 6 functions



On the 6 function joystick the operation of auxiliary hydraulics (hydraulically driven attachments) happens with two buttons on the joystick. This makes work faster and more comfortable, because you don't need to move your hand from the joystick to the auxiliary hydraulics control lever when operating the attachment, and you can also lift the boom and tilt the attachment at the same time if necessary.

200 series	A36785
400 series	A35479
500-, e series	A35754
R28	A35878

220	225	423	523	528	530	R28	R35	630	635	640	735	755i	760i	860i	e5	e6

## Joystick 8 functions



On the 8 function joystick both the auxiliary hydraulics and the telescopic boom can be controlled with the switches on the joystick. This speeds up both loading and working with hydraulic attachments.

600 series	A47829
R35	A35867

220	225	423	523	528	530	R28	R35	630	635	640	735	755i	760i	860i	e5	e6

## Opticontrol



Opticontrol makes it possible to operate both the electric and the hydraulic functions of the attachment with the rocker switches on the control switch pack. This requires the 6 or 8 function joystick on the loader. Opticontrol speeds up the operation of attachments which have two or more hydraulic functions and an electric solenoid valve for selecting those functions. It consists of the control switch pack which mounts on the boom control lever and a selector switch which mounts on the dashboard of the loader.

When the switch is in OFF position, electric functions of the attachment (e.g. electric turning of the rotary broom, electric water spraying pump of collecting broom, electric selector valve etc.) are controlled with the rocker switches on the control switch pack. When the switch is in ON position, all hydraulic functions of the attachment are controlled with the rocker switches on the control switch pack (e.g. hydraulic rotator and hydraulic cylinder of the timber grab, independent operation of the wings of the flipper bucket & snow plows, functions on the mounting kit for stone installation clamp etc.). This means the operator can keep the hand on the joystick and control all functions of the attachment smoothly and comfortably. If the loader is not equipped with the 6/8 function joystick, only the electric functions of the attachment are operated with the switches on the control switch pack. Opticontrol can also be retrofitted on a machine already equipped with the control switch pack.



200 series	A36880
400-800, e series	A36878
R series	A36879

Opticontrol retrofit kit, for loaders with attachment control switch pack A437338

220	225	423	523	528	530	R28	R35	630	635	640	735	755i	760i	860i	e5	e6

Standard

Option

Not available

## Control switch pack for rear mounted attachments

Options



Electric functions of rear mounted attachments can be controlled with this control switch pack. It is necessary, for instance, for operating the 700 series hydraulic rear lift A427547 and the attachment mounted on it (e.g. sand spreaders A427150 and A424325). Other applications: operation of the electric water pump on the A37065 water spraying system of the horse arena harrow, and A37301 electric spreading adjustment of the centrifugal sand/salt spreader. The switch pack is equipped with a strong magnet and can be fastened in a suitable place in the cockpit, for instance on the dashboard. The electric socket is mounted in the rear of the loader.

Control switch pack for rear mounted attachments A431588

220	225	423	523	528	530	R28	R35	630	635	640	735	755i	760i	860i	e5	e6

## Adapter cable for attachment control switch pack



Avant loaders manufactured before 2016, where the socket of the attachment control switch pack is not on the multi connector can be retrofitted with an adapter cable. It mounts on the multi connector, and the electric wire from the attachments control switch pack is connected to this adapter cable. The attachment can also be retrofitted with a corresponding adapter cable if necessary, see page 176. With this updated adapter cable both the electric wire and the hydraulic hoses are connected at the same time with the multi connector.

Adapter cable A36869

220	225	423	523	528	530	R28	R35	630	635	640	735	755i	760i	860i	e5	e6

## Auxiliary hydraulics outlet in the rear, single acting



Single acting rear auxiliary hydraulics is equipped with one pressure line. It makes it possible to operate hydraulic attachments with single function.

400 series	A34636
500 series	A35882
R28	A35879
R35	A35927
e series	A434878
600 series	A34014

220	225	423	523	528	530	R28	R35	630	635	640	735	755i	760i	860i	e5	e6

Standard

Option

Not available

## Auxiliary hydraulics outlet in the rear, double acting



Double acting rear hydraulics is equipped with pressure and return line (on 400-700 series also with tank line), and it makes it possible to operate rear mounted hydraulic attachments like tipping trailer, sand spreader etc.

200 series	A36871 (Not with hand drive)
400 series	A34632
500 series	A35881
R28	A35926
R35	A35928
e series	A434521
600 series	A47774
700-,800 series	A434872

220	225	423	523	528	530	R28	R35	630	635	640	735	755i	760i	860i	e5	e6

## Second auxiliary hydraulics outlet in the front



In addition to the standard auxiliary hydraulics outlet in the front, equipped with multi connector, the loader can be equipped with an extra double acting outlet which mounts under the multi connector. It is double acting (pressure-return) and equipped with conventional quick couplers. If the extra front outlet is installed, rear auxiliary hydraulics outlet is not possible, and vice versa.

400 series,	A35504
500 and e series	A35884
600 series	A35462
700 series	A35477
800 series	A434870

220	225	423	523	528	530	R28	R35	630	635	640	735	755i	760i	860i	e5	e6

## Drive release valve



The drive release valve diverts the oil flow between the left and right side hydraulic drive motors, and this has an effect on the pulling force. When the valve is open the hydraulic oil flows in series from motor to motor. The wheels roll freely and the loader leaves less tire marks on soft and sensitive surfaces. When the valve is closed, the hydraulic oil flows in parallel between the hydraulic motors on each side, similar to a differential lock in operation. This improves traction and towing capacity of the loader.

400 series	A411326
------------	---------

220	225	423	523	528	530	R28	R35	630	635	640	735	755i	760i	860i	e5	e6

Standard

Option

Not available

## Anti slip valve

Options



The anti slip valve positively diverts oil flow between the right and left side hydraulic drive motors (forces the oil to flow to both right and left side drive motors) and improves traction on slippery and uneven surfaces. The function of the anti slip valve depends also on the drive release valve: when the drive release valve is closed the anti slip valve diverts oil flow to the drive motors on all four wheels. When the drive release valve is open the anti slip valve diverts the oil flow between the front wheels only.

200 series	A49548
400 series	A34753
500-, 600-, R series	A424303
700 series	A37362
800 series	A434868
e series	A422257

220	225	423	523	528	530	R28	R35	630	635	640	735	755i	760i	860i	e5	e6

## Back weight



The extra 29 kg counterweight mounts on the rear bumper. It is equipped with handle and fastening hooks, so it is easy to just drop the weight on the bumper, and also to connect the weights on each other. Trailer couplings A417323 and A417337 can also be mounted on the weight.

Back weight                      A35957

220	225	423	523	528	530	R28	R35	630	635	640	735	755i	760i	860i	e5	e6

## Rear side weights 80 kg



Rear side weights mount behind the rear wheels. They are delivered in pair: one on the left and one on the right side. Weight of the kit is 80 kg, and it is intended mainly for 400 series, but can be mounted on bigger Avants as well.

Rear side weights 80 kg                      A36401

220	225	423	523	528	530	R28	R35	630	635	640	735	755i	760i	860i	e5	e6

Standard

Option

Not available

## Rear side weights 180 kg



Rear side weights mount behind the rear wheels. They are delivered in pair: one on the left and one on the right side. Weight of the kit is 180 kg.

Rear side weights 180 kg A49063

220	225	423	523	528	530	R28	R35	630	635	640	735	755i	760i	860i	e5	e6

## Wheel weight



Avant 200 series can be equipped with 14 kg wheel weights which mount on the rim with special bolts. They make the center of gravity of the machine lower and add weight, which improves the stability of the loader.

200 series A46584

220	225	423	523	528	530	R28	R35	630	635	640	735	755i	760i	860i	e5	e6

## Light rear bumper



Avant 500 and 600 series are equipped with the 170 kg rear bumper as standard, but if a lighter machine is required – for instance when driving on surfaces with limited carrying capacity – the light rear bumper can be installed instead of the standard bumper. It reduces total machine weight by about 150 kg.

Light rear bumper A36887

220	225	423	523	528	530	R28	R35	630	635	640	735	755i	760i	860i	e5	e6

Standard

Option

Not available

# Attachment mounting plate in the rear

Options



Attachment mounting plate in the rear is mainly intended for mounting the sand spreaders A427150 and A424325 in the rear of the machine. On 700 and 800 series also the centrifugal spreader A21183 can be mounted on it. The plate is a rigid vertical plate which doesn't tilt.

The mounting plate for 528/530 and 600 series is equipped with two bolts for fastening the attachment whereas the 700 & 800 series plate is fitted with the Avant quick attach system and also with hydraulic quick couplers and hydraulic hoses in case the hoses of the attachment are not long enough to reach the optional rear auxiliary hydraulics outlet on the loader.

When mounting hydraulic attachments, the loader must be equipped with the optional double acting rear auxiliary hydraulics outlet.

528, 530 and 600 series	A433267
700 series	A441613
800 series	A441666

220	225	423	523	528	530	R28	R35	630	635	640	735	755i	760i	860i	e5	e6

## Hydraulic rear lift



This hydraulic rear lift mounts on Avant 700 and 800 series only. It is mainly intended for the sand/salt spreaders A427150 & A424325, and can be mounted on 700 series machines manufactured from January 2019, and all 800 series machines. The rear lift can be tilted down max. 95°, which means that the sand spreader can be tilted down to horizontal position and filled directly from the sand pile by reversing with the machine. The rear lift requires the optional double acting rear auxiliary hydraulics outlet and the control switch pack for rear mounted attachments on the loader. Selection between operation of rear lift / attachment is made with the switch pack, and the rear lift/attachment is operated with auxiliary hydraulics control lever (or buttons on the joystick, if fitted). Hydraulic cylinders are equipped with check valves which make sure that the rear lift cannot move inadvertently.

700 series	A427547
800 series	A438490

220	225	423	523	528	530	R28	R35	630	635	640	735	755i	760i	860i	e5	e6

Standard

Option

Not available



## Trailer coupling



There are two types of trailer couplings available: a 50 mm ball hitch and a 50 mm ball hitch with towing pin. Both can be mounted either directly on the rear bumper or on the extra back weight. Avant 200 series is equipped with a 50 mm ball hitch as standard.

Ball hitch A417323  
 Ball hitch with towing pin A417337

Options

220	225	423	523	528	530	R28	R35	630	635	640	735	755i	760i	860i	e5	e6

## Rear guard



The rear guard protects the rear and the radiator of the engine. It mounts with four bolts and is easy to install and take off. The rear guard is equipped with tie down brackets and allows mounting of back weights and/or trailer coupling at the same time.

Rear guard A36572

220	225	423	523	528	530	R28	R35	630	635	640	735	755i	760i	860i	e5	e6

## Tool box



The lockable tool box mounts on the rear bumper.

700 series A36573

220	225	423	523	528	530	R28	R35	630	635	640	735	755i	760i	860i	e5	e6

Standard

Option

Not available

## Work light kit, on ROPS frame

Options



The work light kit consists of three LED lights: 2 to the front, 1 to the rear. Two types of LED lights available: 700 lumen or 2500 lumen.

200 series, 700 lumen	A36866
400-735-, e- and R series, 700 lumen	A33916
400-735-, e- and R series, 2500 lumen	A34917
755i, 760i, 860i, 700 lumen	A438520
755i, 760i, 860i, 2500 lumen	A438521
Work light kit with red lights (for beekeepers)	
400-735-, e- and R series, 400 lumen	A432730

220	225	423	523	528	530	R28	R35	630	635	640	735	755i	760i	860i	e5	e6

## Work light kit, on cab LX



The work light kit can also be mounted on cab LX, with the same 700 lumen or 2500 lumen lights.

500-600 series, 735, 700 lumen	A35732
500-600 series, 735, 2500 lumen	A35731

220	225	423	523	528	530	R28	R35	630	635	640	735	755i	760i	860i	e5	e6

Standard

Option

Not available

## Road traffic light kit



The road traffic light kit consists of headlamps, blinkers, reflectors, slow moving vehicle sign (triangle) and beacon. When mounted on the ROPS frame the road traffic light kit of 400-800 and e series also includes the rear wall. It enables road traffic registration in certain countries. Requirements vary in different countries, please consult your local Avant distributor.

200 series	A36773
400 series	A34614
500-600 series, on ROPS	A33912
e series, on ROPS, LED	A434812
735, on ROPS	A34235
755i, 760i, ROPS	A438522
800 series, on ROPS	A433228
R series, on ROPS*	A35915
500-600 series, on cab LX	A35352
735, on cab LX	A35355
800 series, on cab	A438524
7-way trailer socket	A418817

\*) not possible when Opticontrol

220	225	423	523	528	530	R28	R35	630	635	640	735	755i	760i	860i	e5	e6

## Beacon



The rotating warning beacon is equipped with a very bright LED lamp. It mounts on a tiltable socket and is easy to install and take off.

200 series	A421008
400-735- and R series	A34002
755i, 760i, 860i	A438530
e series	A438358

220	225	423	523	528	530	R28	R35	630	635	640	735	755i	760i	860i	e5	e6

## Beacon light bar



The beacon light bar is available for cab DLX only, instead of the rotating warning beacon.

Beacon light bar	A36739
------------------	--------

220	225	423	523	528	530	R28	R35	630	635	640	735	755i	760i	860i	e5	e6

Standard

Option

Not available

## Cab L

Options



Avant cab L is an excellent and economical choice when the operator wants to have protection against rain, wind and snowfall. It improves operator comfort and working conditions considerably. The cab mounts on the standard ROPS frame, which means safety is guaranteed. It consists of windscreen (equipped with wiper and washer), right side window and rear window. Door is available for 200 series cab L.

200 series	A36681
Door, cab L 200 series	A37278
400 series	A34624
500-700-,e series	A21592
800 series	A439264

Cab L requires the 50 mm higher 600/700 series ROPS frame on 500 and e series.

220	225	423	523	528	530	R28	R35	630	635	640	735	755i	760i	860i	e5	e6

## Rear wall



The rear wall mounts on the ROPS frame. It gives protection against wind and light rain.

400 series	A439184
500-700-,R-,e series	A49446
800 series	A439193

Rear wall requires the 50 mm higher 600/700 series ROPS frame on 500, R and e series.

220	225	423	523	528	530	R28	R35	630	635	640	735	755i	760i	860i	e5	e6

## Cab LX



The cab LX provides the option of a heated cab. It has all the features of the L cab with addition of a door and a heater to further improve operator comfort in harsh weather conditions. For warmer seasons the door and windows can easily be removed if required. Front mudguards are standard equipment, rear mudguards are available as an option. Cab LX is an independent ROPS/FOPS structure and cannot be retrofitted. Not available for 755i and 760i with Kohler KDI Stage V engine.

500, 600 series and 735	A21517
-------------------------	--------

220	225	423	523	528	530	R28	R35	630	635	640	735	755i	760i	860i	e5	e6

Standard

Option

Not available

# Cab DLX



The top of the range cab DLX is equipped with heater, noise reducing interior materials, radio, cab air filter, LED work light kit, road traffic light kit, front and rear mudguards. Air conditioning, air suspension seat and beacon light bar are available as an option. A/C unit can be mounted either on the roof - or behind the rear window if a lower machine height is required. The spacious and ergonomic cab DLX represents modern cab design at its best.

- Cab DLX, 500/600 series A21444
  - Cab DLX, 700 series A21465
  - Cab DLX, AC (Unit position rear) 635/640 A21463
  - Cab DLX, AC (Unit position roof) 635/640 A21511
  - Cab DLX, AC (Unit position rear) 700 series A21464
  - Cab DLX, AC (Unit position roof) 700 series A21510
  - Air suspension seat A413706
  - Back rest extension, on air suspension seat A437711
- AC is available for 635,640 and 700 series.

220	225	423	523	528	530	R28	R35	630	635	640	735	755i	760i	860i	e5	e6

Options

# Cab GT



The completely new cab GT for Avant 800 series is mounted with rubber mounts on the chassis, which means very low vibrations and noise level in the cab. Visibility to the rear wheels is better thanks to larger rear windows. The cab is equipped with heating, sound absorbing interior, windscreen washer and wiper, cab air filter and front & rear mudguards as standard. Optional equipment include air conditioning, air suspension seat, radio, road traffic kit, work light kit, 4-light beacon (2 pcs blinking LED lights above the windscreen, 2 pcs above the rear windows) and rotating beacon. Cab increases machine height by only 30 mm (height 2230 mm).



- A436732 Cab GT
- A438528 Work light kit on cab: 2 front, 1 rear, LED 700 lumen
- A438539 Work light kit on cab: 2 front, 1 rear, LED 2500 lumen
- A438524 Road traffic light kit, on cab
- A438326 A/C on cab, cooler in the rear
- A438053 Air suspension seat
- A437711 Back rest extension, air suspension seat
- A438538 Four-light beacon, on cab (2 pcs LEDs above windscreen, 2 pcs above rear windows)
- A438530 Rotating beacon
- A438587 Radio, with bluetooth

220	225	423	523	528	530	R28	R35	630	635	640	735	755i	760i	860i	e5	e6

Standard

Option

Not available

# HD cover plates

Options



HD cover plates are made of extra shock resistant polycarbonate with great tensile strength. They can take the beating on the construction site and will even resist jumping on them. The HD covers are as shiny as the standard ABS covers.

423	A425274
523 ROPS frame	A425275
523 LX/DLX	A425276
R series	A36142
528/530, 600 series ROPS, no rear mudguards	A36080
528/530, 600 series ROPS & rear mudguards	A36081
528/530, 600 series LX/DLX, no rear mudguards	A35670
528/530, 600 series LX/DLX & rear mudguards	A35669
e series	A439250

**700 series:**

ROPS	A439142
LX/DLX 12" tires	A439143
LX/DLX 15" tires	A439145

**800 series:**

ROPS	A438664
Cab	A438665

220	225	423	523	528	530	R28	R35	630	635	640	735	755i	760i	860i	e5	e6

# Snow chains

Snow chains are available for different tire sizes. They give excellent grip on slippery snowy and icy surfaces. Can be mounted on all four wheels or just on the front or rear axle. Delivered in a bag which includes 2 pcs chains.



SD



HD

5x10 TR, pair SD	64055
23x8.50-12, pair SD	64746
23x8.50-12, pair HD	64455
23x10.50-12, pair HD	64745
26x12.00-12, pair HD	64973
320/60-12, pair HD	65603
320/55-15, pair HD	65722
27x8.50-15, pair SD	65723

220	225	423	523	528	530	R28	R35	630	635	640	735	755i	760i	860i	e5	e6



Standard



Option



Not available

## Mudguards rear



528/530, 600 series\* A35237  
 \* With 26x12.00-12 and 320/60-12HD tires  
 Rear mudguards are available as an option on a new machine, they cannot be retrofitted.

700 and 800 series A437518  
 Rear mudguards can also be retrofitted on 700 & 800 series with Stage V rear chassis.

220	225	423	523	528	530	R28	R35	630	635	640	735	755i	760i	860i	e5	e6

## Suspension seat



Suspension seat is optional equipment on 200 and 400 series. It is equipped with arm rests, seat belt and heater.

200- and 400 series A2522

220	225	423	523	528	530	R28	R35	630	635	640	735	755i	760i	860i	e5	e6

## Full suspension seat



The full suspension seat with larger suspension is standard equipment on 600, 700 and 800 series. It is equipped with seat belt, arm rests and heater.

Full suspension seat 64853

220	225	423	523	528	530	R28	R35	630	635	640	735	755i	760i	860i	e5	e6

Standard

Option

Not available

## Engine heater



Engine heater facilitates starting in low ambient temperatures and saves the engine and reduces fuel consumption when starting in the cold.

200 series, radiation	A420503
423/523, block	A425277
528,530,R28,R35,600 series,735, block	A410648
755i, 760i, 860i, block	A419474

220	225	423	523	528	530	R28	R35	630	635	640	735	755i	760i	860i	e5	e6

## Exhaust purifier



Exhaust purifier can be mounted instead of the standard exhaust muffler. It reduces diesel engine emissions. In Kohler KDI Stage V engines a diesel oxidation catalyst (DOC) is integrated in the same housing with the diesel particulate filter DPF.

423, 523	A424843
528,530,R28,R35,600 series	A35513
735	A439833

220	225	423	523	528	530	R28	R35	630	635	640	735	755i	760i	860i	e5	e6

## Hand drive controls



Hand drive controls enables the forward-reverse driving of the loader with a switch on the joystick, instead of the drive pedals. The hand drive is proportional like the drive pedals: the more the switch is turned the faster the machine will travel. It is possible to use either the hand drive or the standard drive pedals; selection between hand drive and pedal control happens with a switch on the dashboard.

200 series	A37093
400-700- and R series	A37287

220	225	423	523	528	530	R28	R35	630	635	640	735	755i	760i	860i	e5	e6

Standard

Option

Not available



## Rear carrier



The tiltable rear carrier mounts on the rear bumper with bolts.

Rear carrier A35453

220	225	423	523	528	530	R28	R35	630	635	640	735	755i	760i	860i	e5	e6
												*	*			

\*) With Kohler KDI Stage V engine

## Reverse beeper



Gives a loud audible warning signal when reversing.

200 series A421116  
 400 and e series A410739  
 500-, 600-, R-series, 735 A439980  
 755i, 760i, 860i A438525

220	225	423	523	528	530	R28	R35	630	635	640	735	755i	760i	860i	e5	e6

## Tie down bracket on wheel hub

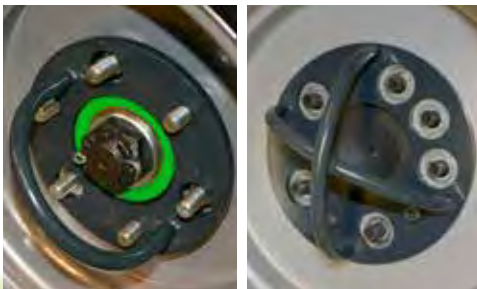

The bracket makes it easier to tie down the loader on a trailer, truck etc. Two models: for 6-bolt wheel hub and for 5/10-bolt wheel hub

6-bolt wheel hub A423161  
 5 and 10 bolt wheel hub A423091

A423161

A423091

220	225	423	523	528	530	R28	R35	630	635	640	735	755i	760i	860i	e5	e6

Standard

Option

Not available

## Tie down bracket in the rear/on the sides



The bracket can be mounted on rear bumper and/or behind the rear wheels. Makes it easier to tie down the loader on a trailer etc.

400-800-,R- and e series      A418746

Options

220	225	423	523	528	530	R28	R35	630	635	640	735	755i	760i	860i	e5	e6

## Lifting kit, for machines with ROPS frame



The kit includes all necessary slings and instructions for lifting a loader equipped with ROPS frame.

200-700-, R- and e series      A418706

220	225	423	523	528	530	R28	R35	630	635	640	735	755i	760i	860i	e5	e6

## Lifting kit, for machines with cab LX/DLX/GT



The kit includes all necessary lifting chains, hooks, brackets and instructions for lifting a loader equipped with cab LX/DLX/GT.

500-800 series      A417352

220	225	423	523	528	530	R28	R35	630	635	640	735	755i	760i	860i	e5	e6

Standard

Option

Not available

## Weather cover



Weather cover protects the cockpit against rain, snow, dust and dirt. The weatherproof cloth covers the entire instrument panel, steering wheel and driver's seat. The weather cover is delivered with an integrated pouch where the cover can be wrapped when not in use.

200 series 65435  
400-800- and e series 65436

220	225	423	523	528	530	R28	R35	630	635	640	735	755i	760i	860i	e5	e6

## Transport cover



Protects the entire Avont loader during transports on an open trailer or truck. The material is black, robust and all-weather proof fabric which keeps the machine safe from rain, snow and dirt. Comes with a durable pouch.

200 series 65477  
400-600- and e series 65478  
700 series 65479

220	225	423	523	528	530	R28	R35	630	635	640	735	755i	760i	860i	e5	e6

## Loading ramps



The lightweight and durable aluminium ramps are easy to handle and they stay clean thanks to the open grid design. Max. load is 2.250 kg.

Loading ramps A65447

220	225	423	523	528	530	R28	R35	630	635	640	735	755i	760i	860i	e5	e6

Standard

Option

Not available

## Battery charger 12V



The battery charger is connected to the 12V outlet of the loader, which makes battery charging very easy because one doesn't need to remove the cover plates in order to get to the battery terminals directly. The charger is automatic – it changes automatically from charging to maintenance mode.

Battery charger 12V                      A436257

Options

220	225	423	523	528	530	R28	R35	630	635	640	735	755i	760i	860i	e5	e6

## Adapter cable 12V



Connection cable, mounts on the 12V outlet on 400-800 series and 200 series 1. Equipped with a connector where you can connect a cigarette lighter plug, for instance when using a mobile phone charger.

400-800-, R- and e series              65645

220	225	423	523	528	530	R28	R35	630	635	640	735	755i	760i	860i	e5	e6

## Adapter plug 12V



Adapter plug to 12V outlet, mounts both on the smaller 12V outlet on 400-800 series and on the bigger outlet on 200 series 2. You can connect the electric wires of any 12V electric appliance (for instance a battery charger) to this adapter. Requires therefore some electrician skills.

Adapter plug 12V                          66286

220	225	423	523	528	530	R28	R35	630	635	640	735	755i	760i	860i	e5	e6

Standard

Option

Not available

## Battery pack e5



Complete battery pack for Avant e5, AGM battery, 285 Ah, 48V.

Battery pack e5

A432383

220	225	423	523	528	530	R28	R35	630	635	640	735	755i	760i	860i	e5	e6

## Rapid battery charger, e6



The rapid charger speeds up charging of the lithium-ion battery of e6 considerably compared with the standard built-in 230V/10A battery charger. Two models available: 400V/16A charger and the more efficient 400V/32A charger. Charging time of the 16A charger from 0 to 100 % with full current is approx. 2 hours, with 32A charger around 1 hour. A good way is to charge the battery when there is some 20 % charge left - then charging to 80 % takes about 30 minutes with the 32A charger. The rapid charger comes mounted on a stand so that it is easy to move on the work site if necessary. The stand is equipped with Avant quick attach bracket in the rear, forklift brackets in the bottom and lifting lugs on top.

Rapid battery charger, e6, 400V/16A (includes stand) A426117

Rapid battery charger, e6, 400V/32A (includes stand) A425411

220	225	423	523	528	530	R28	R35	630	635	640	735	755i	760i	860i	e5	e6

Options

Standard

Option

Not available



# General bucket

Avant general buckets are designed so that the operator can see the front edge of the bucket from the driver's seat, which means quick and easy loading and emptying. There are no reinforcement plates inside the bucket which would interfere when loading and emptying, and the sides open forward in a slight angle which guarantees easy and complete emptying of all kinds materials.

Length of the bucket has been optimized in order to give best possible breakout force. Sides open forward in a slight angle which guarantees easy and complete emptying of all kinds materials.

There are narrow holes at the upper end of the bucket which improve visibility and prevent stones from falling towards the operator.

Available with straight edge and with teeth. Teeth protection plate is also available.



- All round bucket, suitable for almost every shovelling job
- Excellent visibility to the edge of the bucket
- No reinforcement plates inside the bucket – easy filling and emptying
- High breakout force
- Strong cutting edge made of high tensile, abrasion resistant wear steel

Width	Edge	Volume	Weight	Product no
900 mm	Straight	190 l	62 kg	A36711
900 mm	Teeth	190 l	72 kg	A36716
1050 mm	Straight	150 l	50 kg	A36702*
1050 mm	Straight	240 l	73 kg	A36710
1050 mm	Teeth	240 l	83 kg	A36780
1150 mm	Straight	260 l	78 kg	A36709
1150 mm	Teeth	260 l	91 kg	A36779
1300 mm	Straight	300 l	86 kg	A36698
1300 mm	Teeth	300 l	98 kg	A36778
1350 mm	Straight	310 l	90 kg	A36996
1350 mm	Teeth	310 l	102 kg	A36997

\*) A36702 is the general bucket for 200 series 2 – the dimensions and weight match the lift capacity of 200 series 2. Wider general buckets can be used on 200 series 2 as light material bucket.

Option:

- Teeth protection plate 105 cm A417347
- Teeth protection plate 115 cm A420132
- Teeth protection plate 130 cm A417320

220	225	225LPG	313S	320S	320S+	420	423	520	523	525LPG	528	530	R20	R28	R35	630	635	640	735	745	750	755i	760i	860i	e5	e6

Very compatible
  Compatible
  Incompatible



# Heavy duty general bucket

Avante heavy duty general buckets are available with widths starting from 1300 mm. They are made of stronger materials, they are heavier and have more capacity than standard general buckets. This makes them ideal tools for harder earthmoving and material handling jobs, and the HD buckets are best suited for Avante 600 700 and 800 series.

Other features are the same as on standard general buckets: good visibility to the edge of the bucket, the inside of the bucket is completely plain and the sides open forward in a slight angle which guarantees easy and complete filling and emptying of all kinds of materials.

- **Heavy duty bucket for more demanding earthmoving and material handling jobs**
- **Excellent visibility to the edge of the bucket**
- **No reinforcement plates inside the bucket – easy filling and emptying**
- **High breakout force**
- **Strong cutting edge made of high tensile, abrasion resistant wear steel**



Width	Edge	Volume	Weight	Product no
1300 mm	Straight	370 l	126 kg	A36713
1450 mm	Straight	420 l	138 kg	A36712
1600 mm	Straight	460 l	150 kg	A36535
1600 mm XL	Straight	600 l	190 kg	A437578

220	225	225LPG	313S	320S	320S+	420	423	520	523	525LPG	528	530	R20	R28	R35	630	635	640	735	745	750	755i	760i	860i	e5	e6	

Very compatible
  Compatible
  Incompatible



## Light material bucket

Light material buckets are intended for handling of e.g. snow, saw dust, manure, wood chips and other light materials.

The bottom of a light material bucket is considerably longer and the sides are higher than on a general bucket, which speeds up the work a lot. There are no reinforcement plates inside the bucket which would interfere when loading and emptying, and the sides open forward in a slight angle which guarantees easy and complete emptying of all kinds materials.

- Fast and easy moving of light materials
- Excellent visibility to the edge of the bucket
- No reinforcement plates inside the bucket – easy filling and emptying
- High back of the bucket prevents material from falling over the rear edge and guarantees high volume
- Strong cutting edge made of high tensile, abrasion resistant wear steel



Width	Volume	Weight	Product no
1150 mm	490 l	125 kg	A36715
1300 mm	560 l	135 kg	A36714

220	225	225LPG	313S	320S	320S+	420	423	520	523	525LPG	528	530	R20	R28	R35	630	635	640	735	745	750	755i	760i	860i	e5	e6	

Very compatible
  Compatible
  Incompatible





# XL light material bucket

XL light material bucket is a large capacity bucket, best suited to Avant 600, 700 and 800 series. It is intended for loading and transporting of light materials like wood chips, mulch, snow etc. There are no reinforcement plates inside the bucket which would interfere when loading and emptying, and the sides open forward in a slight angle, which guarantees easy and complete emptying of all kinds of materials and in difficult conditions also.

- **Large volume**
- **No reinforcement plates inside the bucket**
- **Robust design**
- **Intended for bigger Avant loaders**
- **XXL bucket available for 800 series**

Width	Height	Volume	Weight	Product no
1450 mm	870 mm	710 l	155 kg	A36703
1600 mm	880 mm	800 l	175 kg	A36476
1800 mm	880 mm	900 l	195 kg	A36343

## XXL light material bucket for 800 series:

Width	Height	Volume	Weight	Product no
1800 mm	1060 mm	1300 l	255 kg	A437601



Model	220	225	225LPG	313S	320S	320S+	420	423	520	523	525LPG	528	530	R20	R28	R35	630	635	640	735	745	750	755i	760i	860i	e5	e6
XL																											
XXL																											



Very compatible



Compatible



Incompatible



## 4 in 1 bucket

Efficient multi purpose bucket - can be used as a normal bucket as well as a dozer blade, leveler or a grab. The front part of the bucket opens with 2 hydraulic cylinders, located on the back side of the bucket, which enables dozing, levelling and picking of stones, tree stumps etc. Another benefit of the opening bottom is that the bucket can be emptied at a higher level by opening the bottom instead of tipping the bucket edge down.

Available with straight edge or with teeth.

- **All round tool for landscaping and groundcare**
- **A versatile bucket suitable for many different jobs at different stages on the work site**



Edge	Width	Volume	Weight	Product no
straight	1100 mm	155 l	152 kg	A21245
straight	1280 mm	170 l	175 kg	A21156
straight	1450 mm HD	300 l	246 kg	A428472
straight	1600 mm HD	330 l	257 kg	A36906
teeth	1100 mm	155 l	162 kg	A21249
teeth	1280 mm	170 l	185 kg	A21184
teeth	1450 mm HD	300 l	258 kg	A428508
teeth	1600 mm HD	330 l	267 kg	A37248

220	225	225LPG	313S	320S	320S+	420	423	520	523	525LPG	528	530	R20	R28	R35	630	635	640	735	745	750	755i	760i	860i	e5	e6



Very compatible



Compatible



Incompatible



# High tip bucket

High tip bucket is the right choice when you need to reach higher and longer. The bucket is equipped with a hydraulic cylinder that pushes and tips the bucket over its front edge, which gives considerably more tipping height than with a normal bucket.

Max. tipping height on 200 series is 1680 mm, on 400-600 series with telescopic boom about 3100 mm (depending on tyre size), on 700 series about 3500 mm and on 800 series as high as 4000 mm.

- High tipping height
- Excellent for loose and light material loading



Width	Volume	Weight	Product no
1050 mm	150 l	120 kg	A2631
1280 mm	350 l	160 kg	A2824

220	225	225LPG	313S	320S	320S+	420	423	520	523	525LPG	528	530	R20	R28	R35	630	635	640	735	745	750	755i	760i	860i	e5	e6	

Very compatible
  Compatible
  Incompatible



## XL high tip bucket

The XL high tip bucket has more loading volume - very useful when loading light materials. The bucket is an ideal tool for snow removal, loading of wood chips and for loading works on recycling plants etc.

Tipping of the bucket happens with two hydraulic cylinders – this means emptying is easy also with full load in the bucket.

- **Large volume bucket for efficient loading of light materials**
- **Max. tipping height as high as 4 m (with 800 series)**



Width	Volume	Weight	Product no
1450 mm	720 l	270 kg	A3684I
1800 mm	900 l	320 kg	A21273

220	225	225LPG	313S	320S	320S+	420	423	520	523	525LPG	528	530	R20	R28	R35	630	635	640	735	745	750	755i	760i	860i	e5	e6	





# Grapple bucket

Grapple bucket combines a normal bucket and a grapple and is therefore suitable for a multitude of jobs. It can be used for transporting and loading of branches, wood chips, compost, straw, manure, construction waste etc. It can also be used as a normal bucket with the grapple in the upright position.



Option:  
Side plates, kit, for XL grapple buckets A439112

- **Versatile bucket for handling of loose materials**
- **Larger XL models with two cylinders intended especially for 700 and 800 series**

Width	Weight	Product no
900 mm	130 kg	A36304
1050 mm	146 kg	A36316
1300 mm	168 kg	A36323

**XL grapple bucket for 700 and 800 series:**

Width	Weight	Product no
1300 mm	270 kg	A441963
1450 mm	288 kg	A441946
1600 mm	305 kg	A439086

Modell	220	225	225LPG	313S	320S	320S+	420	423	520	523	525LPG	528	530	R20	R28	R35	630	635	640	735	745	750	755i	760i	860i	e5	e6
Standard	Yellow	Yellow	Yellow	Green	Green	Green	Green	Green	Green	Green	Green	Green	Green	Green	Green	Green	Green	Green	Green	Green	Green	Green	Green	Green	Green	Green	Green
XL	Red	Red	Red	Red	Red	Red	Red	Red	Red	Red	Red	Red	Red	Red	Red	Red	Yellow	Yellow	Yellow	Yellow	Green	Green	Green	Green	Green	Green	Green



Very compatible



Compatible



Incompatible



# Demolition grapple bucket

The demolition grapple bucket with two hydraulic grapples (1300 mm) and one (900 mm and 1000 mm) are strong and versatile attachment for handling of construction and demolition waste.

- **Versatile bucket with two hydraulic grapples (1300 mm) and one (900 mm and 1000 mm), for demolition and construction**



Width	Weight	Product no
900 mm	155 kg	A441014
1050 mm	205 kg	A37465
1300 mm	225 kg	A37535

220	225	225LPG	313S	320S	320S+	420	423	520	523	525LPG	528	530	R20	R28	R35	630	635	640	735	745	750	755i	760i	860i	e5	e6	

Very compatible
  Compatible
  Incompatible



# Root Grapple

The root grapple is widely used in the tree industry, and it works also in other jobs where different types of debris needs to be handled. It is equipped with the same grapples as the demolition grapple buckets, but the bottom part is made of strong steel bars. This allows:

- \* easy grabbing and handling of branches, tree trunks, rocks or just any type of debris
- \* tearing roots from the ground
- \* soil & similar debris to drop to the ground between the bars when handling logs, branches etc. => when feeding wood to the wood chipper the chipper stays cleaner

Three models available: 1300 mm wide with two hydraulically operated grapples, and a narrower 900 mm/1000 mm models with one grapple. The hydraulic cylinders and hoses of the grapples are well protected with metal covers.

- **Versatile attachment for handling of timber and various types of debris**
- **Strong tines make it possible to tear roots from the ground**



Width	Weight	Product no
900 mm	132 kg	A440857
1000 mm	125 kg	A429058
1300 mm	185 kg	A37537

220	225	225LPG	313S	320S	320S+	420	423	520	523	525LPG	528	530	R20	R28	R35	630	635	640	735	745	750	755i	760i	860i	e5	e6	

Very compatible
  Compatible
  Incompatible



# Levelling bucket

Avant levelling buckets are built with heavy duty construction in mind. Levelling bucket has a sharp back edge which makes levelling easy when driving backward. Other features include a longer bottom, which enables the driver to see the tip of the bucket perfectly. This also makes levelling easier. The new levelling buckets are stronger and completely plain inside, which makes filling and emptying easier. They are also larger than the earlier models.

- **Excellent visibility to tip of bucket**
- **Sharp back edge enables exact levelling when driving backward**
- **Heavy duty design**
- **New models with more width and capacity**



Width	Volume	Weight	Product no
1450 mm	250 l	175 kg	A36717
1600 mm	280 l	190 kg	A36706

220	225	225LPG	313S	320S	320S+	420	423	520	523	525LPG	528	530	R20	R28	R35	630	635	640	735	745	750	755i	760i	860i	e5	e6	

Very compatible
  Compatible
  Incompatible





# Pallet fork

Avant pallet fork is the right attachment for lifting and handling of different types of materials on pallets. Fork width can easily be adjusted thanks to the quick lock mechanism. The forks are made of high tensile forged steel and designed in accordance with the ISO2330 standard.

Avant is an excellent machine for load handling thanks to the precise steering and drive control. Compared with a conventional forklift truck Avant is superior when working outdoors and on terrains, be it winter or summer.

- **Excellent field of vision both to the attachment and to the environment makes working with pallet forks precise and easy**
- **Pallet fork is a useful attachment on construction sites, farms, as well as on the company's yard doing material handling jobs**
- **Can be tilted sideways and rotated with the optional tilt adapters and attachment rotator (see page 165)**



Option:

Bolt on back frame A36346

A441445 Rotation support, adjustable (prevents boxes from falling from the pallet fork when rotating & emptying them with the attachment rotator A424406)

Model	Fork length	Max. load	Weight	Product no
Regular	850 mm	1000 kg	90 kg	A21047
HD	1100 mm	1400 kg	115 kg	A21039
XHD	1200 mm	2000 kg	140 kg	A36589

220	225	225LPG	313S	320S	320S+	420	423	520	523	525LPG	528	530	R20	R28	R35	630	635	640	735	745	750	755i	760i	860i	e5	e6	



Very compatible



Compatible



Incompatible



## Pallet fork with side shift

Hydraulic fork adjustment on the pallet fork makes it possible to move the forks further apart or closer to each other easily and comfortably from the driver's seat. The forks can also be moved to the left or to the right, making it possible to shift the load to the side of the machine - closer to a wall for example. All functions can be operated from the driver's seat. Pallet fork is equipped as standard with a foldable back frame which enables handling of larger loads and protects the driver from falling objects.

- Hydraulic side shift and fork width adjustment
- Foldable back frame as standard



Fork length	Max. load	Weight	Product no
1100 mm	1200 kg	173 kg	A36279

The optional Opticontrol is recommended on the loader.

220	225	225LPG	313S	320S	320S+	420	423	520	523	525LPG	528	530	R20	R28	R35	630	635	640	735	745	750	755i	760i	860i	e5	e6



Very compatible



Compatible



Incompatible



# Skip bucket

The skip buckets are more like skip containers, but can be transported and emptied easily with Avant. The bucket can be equipped with castor wheels as an option. With them the bucket can be moved and filled by hand effortlessly e.g. in horse stables, on factory floors and similar tight situations where driving with the loader is not necessary or possible. A full bucket can then be taken away and emptied with Avant.

- Replace the waste bins on the site with the skip bucket – loading, transporting and emptying of the bucket is very easy with Avant
- Castor wheels available as an option (solid plastic wheels or pneumatic tires)
- Supports instead of wheels available as an option - supports raise the rear and lower the front of the bucket by approx. 100 mm, which makes it easier to empty e.g. a wheelbarrow into the bucket



Options:

- A418506 Castor wheels, 4 pcs (will increase bucket height by 165 mm)
- A420800 Castor wheels, pneumatic tires, 4 pcs will increase bucket height by 235 mm)
- A420537 Supports, 4 pcs
- A421005 Lifting brackets, 4 pcs

Width	Volume	Weight	Product no
880 mm	630 l	115 kg	A36588
1280 mm	950 l	145 kg	A36595

220	225	225LPG	313S	320S	320S+	420	423	520	523	525LPG	528	530	R20	R28	R35	630	635	640	735	745	750	755i	760i	860i	e5	e6	

Very compatible
  Compatible
  Incompatible



# Jib boom

Avant jib boom is a simple and ingenious attachment: lifting and moving heavier loads in tight situations are not a problem any more when you have this jib boom on your Avant.

The jib boom is equipped with a rotating lifting hook. Maximum lifting height to the tip of the jib boom, with the telescopic boom of the loader extended, is about 4.5 metres (800 series).

- **Economical attachment, suitable for many different lifting jobs**
- **Equipped with a rotating lifting hook**



Lifting point distance from attachment plate	1200 mm
Total length	1300 mm
Width	550 mm
Height	315 mm
Weight	34 kg
Rated max load	500 kg
Product no	A42848 I

220	225	225LPG	313S	320S	320S+	420	423	520	523	525LPG	528	530	R20	R28	R35	630	635	640	735	745	750	755i	760i	860i	e5	e6	

Very compatible
  Compatible
  Incompatible



## Telescoping jib boom

The hydraulically telescoping jib boom is a very efficient and versatile tool in all lifting jobs on the work site. The steplessly extending and retracting boom allows lifting to places that would otherwise be very hard to reach. Compact design with telescoping cylinder inside the boom makes work safe and easy.

The jib boom is equipped with a rotating lifting hook and durable wear pads on the outer boom.

- **Excellent outreach, as much as 3,4 m from the front wheels**
- **Max. lift height with 800 series as high as 5,22 m**
- **Versatile lifting attachment for various load handling jobs**



Max. boom length	1900 mm
Min. boom length	1300 mm
Max. lifting height*	5,22 m
Max load Avant 800 ser*	500 kg
Max load Avant 700 ser*	400 kg
Max load Avant 600 ser*	300 kg
Max load Avant 500 ser*	250 kg
Max. outreach*	3,05 m
Weight	110 kg
Product no	A21342

\*) Both the telescopic boom of the loader and the jib boom extended to max. outreach.

220	225	225LPG	313S	320S	320S+	420	423	520	523	525LPG	528	530	R20	R28	R35	630	635	640	735	745	750	755i	760i	860i	e5	e6	



Very compatible



Compatible



Incompatible

# Hydraulic trailer hitch

Buckets, material handling

The hydraulic trailer hitch features hydraulic height adjustment of the 50 mm ball hitch, which makes it easier to connect trailers in varying heights and ground conditions. The hitch is equipped with both 50 mm ball and a towing pin.

Attention: Requires double acting rear auxiliary hydraulics outlet on the loader.



- Equipped with 50 mm ball hitch/towing pin
- 250 mm vertical hitch height adjustment
- Hydraulic cylinder equipped with lock valve
- Can be mounted on 400-800 series

Height adjustment	hydraulic, 250 mm
Weight	30 kg
Product no	A36518

220	225	225LPG	313S	320S	320S+	420	423	520	523	525LPG	528	530	R20	R28	R35	630	635	640	735	745	750	755i	760i	860i	e5	e6	

Very compatible      Compatible      Incompatible

# Ball hitch on front

An easier way to move trailers, trailer mounted work platforms, boats on trailer etc. on yards. Thanks to the perfect vision to the ball hitch it is very easy to couple a trailer by just driving the ball under the trailer and locking it in the coupling by lifting the boom of the loader.

Equipped with a combined 50 mm ball hitch/towing pin.



- Easier way to couple to and move trailers etc. with Avant
- Best possible field of vision to the trailer enables very precise handling in tight situations
- Easy and fast to mount on Avant

Weight	Product no
34 kg	A35592

220	225	225LPG	313S	320S	320S+	420	423	520	523	525LPG	528	530	R20	R28	R35	630	635	640	735	745	750	755i	760i	860i	e5	e6	

Very compatible      Compatible      Incompatible



## Beehive mover

Avant beehive mover is intended basically for loading and transporting of beehive boxes, but it can handle other objects like cardboard boxes as well. The mover can carry as many as 12 beehives at a time. It consists of a mast, a pallet fork that is mounted on the lower end of the mast, and a hydraulic grapple at the upper end of the mast which presses the boxes against the pallet fork. The grapple is equipped with rubber pads which hold the beehives firmly but gently.

The beehive mover can be mounted on all Avant loaders, and if the beehives need to be transported longer distances by truck it is easy to take the Avant on the truck as well and unload and move the beehives at the destination.

The grapple can be set to five different heights between 425 – 1365 mm following the height of the load, and the vertical movement of the grapple is 340 mm. Distance between the rubber pads can be set manually to four different widths between 280 - 730 mm. Max. load on the beehive mover is 1000 kg and max. pressing force is 18 kN, which means it can handle other materials that are on pallet as well. Especially lighter boxes and similar objects which don't stay on the pallet without support are easy to handle with the beehive mover.



- Fast and easy way to load and transport beehive boxes
- Can handle also cardboard boxes and similar objects
- Mounts on all Avant loaders
- Equipped with Avant 850 mm pallet fork A21047

Max. load	1000 kg
Max. pressing force	18 kN
Pallet fork length	850 mm
Grabbing width	280-730 mm (four widths can be set manually)
Grapple height	425 – 1365 mm (five heights can be set manually)
Grapple cylinder stroke	340 mm
Height	1950 mm
Width	1000 mm
Length	960 mm
Weight	160 kg
Product number	A36935

220	225	225LPG	313S	320S	320S+	420	423	520	523	525LPG	528	530	R20	R28	R35	630	635	640	735	745	750	755i	760i	860i	e5	e6	



Very compatible



Compatible



Incompatible



## Site toolbox

This robust and versatile toolbox mounts on the attachment coupling plate and can be transported with Avant to the worksite. The flat reinforced cover can be used as a workbench. A screw vice can be also mounted on the box.

The lid is equipped with gas springs and can be locked with a pad lock. Four lifting lugs are mounted with bolts on the sides. They can also be removed if necessary. The box is also equipped with lifting brackets for forklift.

The box holds all or some of the handheld tools inside. It keeps tools in good order and is easy to lift to the back of a van or to a safe place for the night - an can be locked to Avant also.

- **Spacious, lockable box for e.g. handheld tools**
- **Easy to lift and transport with Avant loader**
- **Flat reinforced cover can be used as a workbench**
- **Can be equipped with a screw vice**



Volume	550 l
Weight	160 kg
Product no	A21689

220	225	225LPG	313S	320S	320S+	420	423	520	523	525LPG	528	530	R20	R28	R35	630	635	640	735	745	750	755i	760i	860i	e5	e6	

Very compatible
  Compatible
  Incompatible





## Dozer blade I400

Equipped with hydraulic blade turning, Avant dozer blade is the ideal tool for snow removal, earthmoving and similar jobs where the materials must be dozed away quickly.

Thanks to the more curved blade than on the previous model the new dozer blade I400 moves material more efficiently to the side. Blade height is the same as before, as well as the extensions and cutting edges. Hydraulic slewing and spring release are standard features also. The new spring release system is equipped with a single spring.

- **Economical dozer blade, well suited for snow removal**
- **Spring release mechanism for improved safety**
- **Two solid skid shoes as standard - reduce blade wear and improve maneuverability**
- **Ice cutting edge and rubber edge available as an option**

Blade width	1400 mm
Slewing angle	± 30 deg
Weight	125 kg
Blade height	380 mm
Product no	A36649



### Options:

Extensions 2 x 180 mm (can be mounted straight or in collecting position) A36651,

Ice cutting edge A32315, Ice cutting edge 180 mm on extension A413823,

Rubber edge 1400 mm A32383, Rubber edge 180 mm on extension A48870

220	225	225LPG	313S	320S	320S+	420	423	520	523	525LPG	528	530	R20	R28	R35	630	635	640	735	745	750	755i	760i	860i	e5	e6



Very compatible



Compatible



Incompatible



# Dozer blade 2000/2500

Equipped with hydraulic blade turning, Avant dozer blade is the ideal tool for snow removal, earthmoving and similar jobs where the materials must be dozed away quickly. Dozer blade 2000/2500 features a completely new design. The blade is higher and more curved than earlier and moves material more efficiently to the side. Hydraulic slewing, spring release and skid shoes are standard equipment like before. So are the turnable 2x310 mm extensions which can be mounted in straight or collecting position. The completely new floating system allows the blade to float vertically, which makes working on uneven surfaces considerably easier and more efficient. The blade can also float sideways  $\pm 10^\circ$ . The floating system can be adjusted manually in three different positions:

- 1) Free floating – both vertically and sideways
- 2) Sideways floating  $\pm 10^\circ$  only, without vertical floating
- 3) Rigid position – both vertical and sideways floating locked with bolts

### Options Dozer blade 2000:

- A417437 Ice cutting edges, kit, for main blade and extensions
- A417441 Rubber edges, kit, for main blade and extensions
- A417345 Support wheels, 2 pcs

### Options Dozer blade 2500:

- A417729 Ice cutting edges, kit, for main blade and extensions
- A417672 Rubber edges, kit, for main blade and extensions
- A417345 Support wheels, 2 pcs

- **Two solid skid shoes which reduce blade wear and improve maneuverability**
- **Robust construction, with spring release mechanism designed for professional use**
- **Turnable extensions as standard, can be mounted in collection position or straight**
- **Support wheels, instead of skid shoes, available as an option - keep working height more constant when working on sensitive surfaces**

Model	2000	2500
Blade width	1390 mm main blade + 2x310 mm bolt-on extensions	1840 mm main blade + 2x310 mm bolt-on extensions
Slewing angle	$\pm 30$ deg	$\pm 30$ deg
Weight	215 kg	232 kg
Blade height	590 mm	590 mm
Product no	A36123	A36251

Modell	220	225	225LPG	313S	320S	320S+	420	423	520	523	525LPG	528	530	R20	R28	R35	630	635	640	735	745	750	755i	760i	860i	e5	e6	
2000																												
2500																												

Very compatible      Compatible      Incompatible



# Snow plow

Avant snow plow is a versatile attachment for snow removal. It consists of two independently hydraulically adjustable blades. Angle of the blades is be adjusted with a switch from the driver's seat. Both blades have a spring release mechanism in the lower part of the blade to prevent any sudden stop should the blade hit an obstacle. The floating mechanism on the mounting bracket guarantees that the blade follows ground as well as possible.

The V1800 and V2400 snow plows feature:

- Vertical floating system (better than previous quadangular floating system)
- Well curved blade – moves snow efficiently to the side
- Support legs with skid shoes as standard
- Curved flat cutting edge with standard 305 mm hole distance; made of high tensile, abrasion resistant wear steel

Option:

- |   |        |
|---|--------|
| Ice scraper edges, kit, snow plow V1800 | A36817 |
| Ice scraper edges, kit, snow plow V2400 | A36818 |
| Rubber edges, snow plow V1800           | A37173 |
| Rubber edges, snow plow V2400           | A37171 |

- **Versatile snow removal tool for professional use**
- **Two independently controllable blades: can be adjusted in straight, V or Y position**
- **Advanced floating system allows working on uneven surfaces as well**

Model	V1800	V2400
Blade width	1510-1840 mm	2020-2450 mm
Total width (with curved end flat edge/ ice scraper blade)	1570-1900 mm	2080-2510 mm
Blade turning angle	±35 deg	±35 deg
Weight	330 kg	390 kg
Blade height	770 mm	770 mm
Product no	A36795	A36796

The optional Opticontrol is recommended on the loader, enables independent adjustment of each blade

Modell	220	225	225LPG	313S	320S	320S+	420	423	520	523	525LPG	528	530	R20	R28	R35	630	635	640	735	745	750	755i	760i	860i	e5	e6		
1800																													
2400																													

Very compatible
  Compatible
  Incompatible

**Renewed**

Property maintenance



# Flipper bucket

Flipper bucket is designed for clearing snow in large areas or in areas where snow must be moved long distances. Thanks to the two hydraulically operated side wings the bucket is extremely versatile in snow clearing and can be operated in smaller areas as well without problems.

With the flipper bucket you can move a very large quantity of snow in one push. Because the wings fold out slightly forward from the sides, you can push 2-3 times the capacity of the bucket between the wings. With the optional Opticontrol the two wings can be turned independently or simultaneously. This makes the bucket easy to control also in narrow or tight areas.

- **Large volume bucket, 800 l**
- **Equipped with two hydraulically operated side wings**
- **Max. working width over 3 m**
- **With the optional Opticontrol the two wings can be turned independently or simultaneously**

Volume	800 l
Width	1800 - 3010 mm
Weight	325 kg
Product no	A435885

The optional Opticontrol is recommended on the loader.



Option:  
Ice scraper edges, kit A436345  
Wear plates, kit A435499

220	225	225LPG	313S	320S	320S+	420	423	520	523	525LPG	528	530	R20	R28	R35	630	635	640	735	745	750	755i	760i	860i	e5	e6	

Very compatible      Compatible      Incompatible



## Zoom snow plow

This new type snow plow is equipped with a straight main blade and two wings which can be extended and retracted steplessly, powered by two hydraulic cylinders. This gives several different working widths and makes the snow plow very versatile. The plow is also equipped with hinged end plates which can be turned down on the ground. This allows fast and efficient snow collecting. When the end plates are turned up over the blade the plow works as conventional dozer blade and moves snow quickly to the side – and is narrower as well. The end plates are spring loaded which means they follow the contours of the ground well. Zoom snow plow requires the optional Opticontrol on the loader. Extension and retraction of the wings and turning of the blade are operated with the switches of the switch pack. The wings can be extended one at a time or both at the same time. Indicator lights on the plow show which function is in use. Working width is steplessly adjustable between 1,35 – 2,35 m. The telescoping tubes of the side wings are equipped with maintenance free wear pads. There is also a safety bolt for blade release at the top link, however as the blade is vertical it doesn't get stuck easily but rather jumps over obstacles. The mounting frame of the zoom snow plow is the same as on the 2000 and 2500 mm dozer blades. It allows a  $\pm 10^\circ$  vertical floating which can be locked if necessary. The plow is also equipped with  $\pm 30^\circ$  hydraulic blade turning. Ice cutting edge is standard equipment.

Option:

Ice scraper edges, kit A437890

Straight cutting edge A437891

- Hydraulically extendable dozer blade allows snow removal also in smaller yards, on parking lots etc.
- Equipped with two wings which can be extended and retracted independently or both at the same time
- Steplessly adjustable working width between 1,35 – 2,35 m
- Hinged, foldable end plates for efficient snow collecting and moving
- Hydraulic blade turning  $\pm 30^\circ$  and vertical floating  $\pm 10^\circ$

Working width	1350-2350 mm
Max width	1460-2460 mm
Max length	993 mm
Blade turning angle	$\pm 30^\circ$
Vertical floating angle	$\pm 10^\circ$
Weight	535 kg
Product no	A425180

The optional Opticontrol is recommended on the loader.

220	225	225LPG	313S	320S	320S+	420	423	520	523	525LPG	528	530	R20	R28	R35	630	635	640	735	745	750	755i	760i	860i	e5	e6	



Very compatible



Compatible



Incompatible



# Ice rink scraper blade

The ice rink scraper blade is destined only for maintenance of ice hockey and skating rinks. Thanks to the large 3000 mm working width and hydraulic turning of the blade cleaning of the rink is fast and easy. The sharp and curved blade moves away the ice and snow quickly and efficiently.

- **Fast and easy ice and snow removal on ice hockey and skating rinks**
- **Rubber roller bumper at the right end of the blade protects the blade and the rink when working close to the wall of the ice hockey rink**
- **Large 3000 mm working width**
- **Hydraulic blade turning  $\pm 30^\circ$**



Width	3000 mm
Height	722 mm
Length	775 mm
Blade turning	$\pm 30^\circ$
Weight	145 kg
Product no	A37346

220	225	225LPG	313S	320S	320S+	420	423	520	523	525LPG	528	530	R20	R28	R35	630	635	640	735	745	750	755i	760i	860i	e5	e6



Very compatible



Compatible



Incompatible



# Snow blower

Avant snow blower is an efficient snow removal tool with advanced technology. The frame and discharge chute are designed so that there are as little as possible passive surfaces which would prevent snow movement. This open design means efficient snow blowing – the feeding auger eats the snow quickly and easily and moves it to the impeller which throws the snow out through the discharge chute. Thanks to this design the blower works well both with dry and wet snow and clears compacted snow banks also. The feeding auger is made of wear-resistant Hardox steel.

The blower is equipped with two hydraulic motors: one for the auger and one for the discharge impeller. The new type hydraulic motor on the impeller improves the efficiency of the blower considerably. Snow discharge can be directed accurately: the discharge chute can be rotated 270° electrically, operated from the driver's seat. Throwing height can be adjusted manually, electric throwing height adjustment is available as an option and requires the optional Opticontrol on the loader.

Two working widths available: 1150 mm and 1500 mm.

Option:

Electric throwing height adjustment      A430172

- Efficient high volume snow blower
- Works well both with dry and wet snow
- Equipped with two hydraulic motors: one for the auger and one for the discharge impeller
- Electric 270° discharge chute rotation as standard
- Exact snow discharge
- Manual throwing height adjustment as standard, electric adjustment available as an option

Working width	1150 mm	1500 mm
Total width	1230 mm	1580 mm
Frame height	680 mm	680 mm
Auger diameter	460 mm	460 mm
Chute rotation	270 °	270 °
Weight	240 kg	296 kg
Product no	A434731	A428062

The optional Opticontrol is recommended on the loader. If the snow blower is equipped with the electric throwing height adjustment, the switch pack must be mounted.

Model	220	225	225LPG	313S	320S	320S+	420	423	520	523	525LPG	528	530	R20	R28	R35	630	635	640	735	745	750	755i	760i	860i	e5	e6	
1150																												
1500																	*	*	*									

\*) With Stage V Kubota V1505 engine       Very compatible       Compatible       Incompatible      71



# Rotary broom

Avant rotary broom is an efficient and easy to use attachment for various cleaning jobs. Three working widths available, 1100, 1500 and 2000 mm. The 1500 and 2000 mm brooms are equipped as standard with turning which is powered by electric actuator motor. This means turning of the broom is easily and comfortably operated with a switch from the driver's seat.

The floating mechanism is completely new, and now instead of wheels the brush is resting on its bristles and the whole brush axle is floating freely. This guarantees a noise free float for the brush and a lot of movement space, making sweeping easier. Support wheels are available as an option, for working on sensitive surfaces. The optional rubber lip is intended for snow removal: it limits and directs the snow spray. The broom is equipped with supports which can be extended when the broom is not in use, so that the broom rests on the supports and the nylon brush doesn't get damaged during storage.

- Professional sweeper with manual or electric turning
- Free floating broom allows big vertical movement and guarantees excellent sweeping result
- Equipped with extendable supports for storage: nylon brush doesn't get damaged during storing

Option: Electric turning for rotary broom 1100 mm, product no. A36112  
 A35760 Support wheels for rotary broom  
 A438900 Rubber lip, rotary broom 1100  
 A438874 Rubber lip, rotary broom 1500  
 A438914 Rubber lip, rotary broom 2000

Model	1100	1500	2000
Broom width	1100 mm	1500 mm	2000 mm
Total width	1370 mm	1770 mm	2270 mm
Boom diameter	550 mm	550 mm	550 mm
Turning	manual	electric	
Turning angle	+/- 25 °	+/- 25 °	+/- 25 °
Weight	170 kg	200 kg	260 kg
Product no	A36067	A35284	A35583

The optional Opticontrol is recommended on the loader.

Modell	220	225	225LPG	313S	320S	320S+	420	423	520	523	525LPG	528	530	R20	R28	R35	630	635	640	735	745	750	755i	760i	860i	e5	e6
1100																											
1500																											
2000																											

Very compatible      Compatible      Incompatible





# Collecting broom 1100

The collecting broom 1100 is mainly intended for Avant 200, 400 and 500 series. Broom diameter is 500 mm, it consists of 32 pcs brush segments which can be changed one by one. The broom is equipped with three support wheels and with Optifloat™ quick attach system which allows both vertical and sideways floating of the broom and guarantees efficient sweeping also on uneven surfaces. Two indicator arrows on the Optifloat™ quick attach bracket make adjustment of the floating very easy. Broom height can be adjusted manually, to compensate wear of the nylon bristles. Collector box with 80 l volume is mounted in front of the broom. Emptying of the box is hydraulic. Water spraying system for dust binding and one side brush are available as an option.



Options:  
 Water spraying system, with 60 l water tank A37431  
 Side brush A35698  
 (Water spraying system and side brush not available for 200 series)

- Intended mainly for 200, 400 and 500 series
- Equipped with Optifloat™ => works well on uneven surfaces as well
- Broom height can be adjusted manually
- Collector box with hydraulic emptying in front of the broom, box volume 80 l

Broom width	1100 mm
Total width	1350 mm
Broom diameter	500 mm
Collector box volume	80 l
Water tank volume	60 l
Weight without side brush	315 kg*
Weight with 1 side brush	340 kg*

\*) without water spraying system

Product no	Side brush	water spraying system
A36883	no	no
A426229	1 brush	no
A426231	1 brush	yes

220	225	225LPG	313S	320S	320S+	420	423	520	523	525LPG	528	530	R20	R28	R35	630	635	640	735	745	750	755i	760i	860i	e5	e6	

Very compatible
  Compatible
  Incompatible



# Collecting broom 1500

The collecting broom 1500 is mainly intended for professional property maintenance companies, cities and municipalities. The broom has a heavy duty construction, floating brush axle, automatic brush wear compensation and a specially designed water spraying system for dust binding.

The broom is also well enclosed all around the main brush. This gives a better collection result, especially when turning with the machine. Another benefit from the enclosed construction is less dust formation.

The broom is equipped with three support wheels and with Optifloat™ quick attach system which allows both vertical and sideways floating of the broom and guarantees efficient sweeping also on uneven surfaces. Two indicator arrows on the Optifloat™ quick attach bracket make adjustment of the floating very easy.



Option:  
 Side brush A35698  
 Water spraying system A35642

Model	1500
Broom width	1500 mm
Total width	1800 mm
Boom diameter	550 mm
Box emptying	Hydraulic (with two cylinders)
Box volume	200 litres
Water tank volume	120 litres
Weight without side brush	425 kg (without water spraying system)
Weight with 1 side brush	450 kg
Weight with 2 side brush	475 kg

Product no	Side brush	water spraying system
A35602	no	no
A35918	1 brush	no
A35919	1 brush	yes

The optional Opticontrol is recommended on the loader.

220	225	225LPG	313S	320S	320S+	420	423	520	523	525LPG	528	530	R20	R28	R35	630	635	640	735	745	750	755i	760i	860i	e5	e6	

Very compatible      Compatible      Incompatible



# Bucket broom

Bucket broom collects the waste in a large bucket shaped box. The broom gives best sweeping result when reversing, but it also works when driving forward. Forward sweeping is especially recommended when the waste is larger in dimensions, for instance construction waste, beverage cups, tree leaves etc.

The bucket broom is equipped with a floating mechanism which allows the bucket lip to rest against ground freely. This means that the loader must not necessarily be equipped with boom floating when working with the bucket broom. Emptying of the collector happens by first lifting the broom up hydraulically, after that the collector box can be emptied by tilting it down like a normal bucket. Brush axle is equipped with a simple quick locking system for adjusting the sweeping height.

Water spraying system for dust binding is also available. It minimizes dust build up when brushing dry waste.



Option:  
 A35956 Water spraying system for Bucket broom 1100  
 A35807 Water spraying system for Bucket broom 1500  
 A436108 Rubber blade brush for Bucket broom 1100  
 A433868 Rubber blade brush for Bucket broom 1500

- Excellent sweeping result when driving backwards
- Suitable for collecting larger waste as well
- Large bucket shaped collector box
- Quick, hydraulic emptying
- Rubber blade brush available as an option, for collecting horse manure and similar material

Model	1100	1500
Broom width	1100 mm	1500 mm
Total width	1356 mm	1764 mm
Box volume	370 l	500 l
Boom diameter	500 mm	500 mm
Water tank volume	120 l	120 l
Product no	A35945	A35689
Product no. with water spraying system	A36023	A36024

Modell	220	225	225LPG	313S	320S	320S+	420	423	520	523	525LPG	528	530	R20	R28	R35	630	635	640	735	745	750	755i	760i	860i	e5	e6	
1100																												
1500																												



Very compatible



Compatible



Incompatible



# High pressure washer

The high pressure washer makes your Avant a moving washing unit – it is a powerful street cleaner, and you can wash your loader, equipment, car etc. easily and efficiently as well.

The washers combine low water consumption and high water flow and pressure. High pressure water takes dust, sand and debris out of asphalt, concrete and similar surfaces and doesn't therefore emit dust after drying. Low water consumption makes it possible to clean larger areas with a single pass.

The washer series features three models with different water tank volumes: 280 l on model S, 560 l on model M and 840 l on model L. All washers are equipped with both a turnable nozzle bar for street cleaning and a handheld washing gun with 20 m hose roll.

Max. water flow and pressure on models S and M are as high as 30 l/min and 200 bar, and on the largest model L the 50 l/min max. water flow and 220 bar pressure make it a very efficient street cleaning machine on Avant 700 series.

Nozzle bar turning is hydraulic on models M & L, operated from the driver's seat. Model S is equipped with manual turning.



- Efficient high pressure washers, equipped with both a nozzle bar for street cleaning and with a handheld washing gun
- Three models: S, M and L with water tank volumes of 280 l, 560 l and 840 l respectively
- Models M & L equipped with hydraulic nozzle bar turning for professional street cleaning

Model	S	M	L
Max. water flow	30 l/min	30 l/min	50 l/min
Max. water pressure	200 bar	200 bar	220 bar
Water tank volume	280 l	560 l	840 l
Working width	1500 mm	1800 mm	2000 mm
Nozzles	8 pcs	9 pcs	9 pcs
Weight	95 kg	228 kg	277 kg
Product no	A37012	A37013	A37014

The optional Opticonrol is recommended with washers M & L, for operating the hydraulic nozzle bar turning.

Modell	220	225	225LPG	313S	320S	320S+	420	423	520	523	525LPG	528	530	R20	R28	R35	630	635	640	735	745	750	755i	760i	860i	e5	e6		
S																													
M																													
L																													

Very compatible      Compatible      Incompatible



# Artificial turf attachment ATA I200

The artificial turf attachment ATA I200 is made for professionals. It cleans, filters & returns the infill in a single pass. The fully hydraulic system powered with Avant performs the cleaning tasks efficiently, economically and with very low impact footprint in all artificial surfaces.

The regular cleaning and maintaining of the artificial surfaces reduces compaction and sustains the optimum surface conditions and playing dynamics year-around. Well maintained sport surfaces also reduce the risk of acute and chronic injuries.

- Rotating main brush
- Turbine powered dust and fine particle extraction system including 2 collection hoppers
- Adjustable and interchangeable sieving chamber with 2 large rear hoppers to collect larger debris
- Rubber/cork infill sieve as standard, other sieves available as an option
- Refill unit operating at 1.5x the ground speed to put back the cleaned rubber and soil
- Foldable following brush at the back of the unit to level the infill and finish the cleaning



Option:  
 Rear brush at the back of the unit to level the infill and finish the cleaning, A37035  
 Front rake for deep cleaning of the field, A37061  
 Sand sieve, A421389  
 Deep cleaning sieve, A421391  
 Tilt adapter 90 degrees, to be able to access through smaller gates and corridors (requires optional second auxiliary hydraulics outlet in the front) A36505

Working width	1200 mm
Weight	360 kg
Product no, without rear brush	A36494
Product no, with rear brush	A37230

includes rubber/cork infill sieve, without front rake

220	225	225LPG	313S	320S	320S+	420	423	520	523	525LPG	528	530	R20	R28	R35	630	635	640	735	745	750	755i	760i	860i	e5	e6	

Very compatible
  Compatible
  Incompatible



# Artificial turf maintenance brush

The brush is intended for the daily and weekly maintenance of artificial turf fields. It does not limit or prevent the use of the artificial turf attachment ATA1200, because ATA1200 is intended for monthly maintenance of the field.

The main function of the maintenance brush is to brush up the compacted field's fibers in order to make the field softer again. It also distributes the infill (rubber, cork or sand) evenly so that the field stays softer longer time as well. It is equipped with a floating attachment bracket which makes sweeping easier and boom floating on the loader is not necessary.

- **Efficient and economical daily and weekly maintenance with a 3 m wide brush**
- **Three-phase brushing with three brushes: straight-angle-straight**
- **Floating quick attach bracket**
- **Not intended for deep cleaning of artificial turf fields**



Working width	2925 mm
Total width	3032 mm
Length	1300 mm
Weight	135 kg
Product no	A37058

220	225	225LPG	313S	320S	320S+	420	423	520	523	525LPG	528	530	R20	R28	R35	630	635	640	735	745	750	755i	760i	860i	e5	e6



# Sand/salt spreader

The new sand/salt spreaders are equipped with a new type spreading system: a hydraulically operated pendulum spreading plate which moves horizontally and spreads the material. Spreading plate height can be adjusted following the material type, which allows spreading of gravel as well as finer sand and salt. A blocking plate kit, available as an option, is necessary when spreading salt and fine sand (prevents the material from falling out by itself). The unit spreads about 200-300 mm wider than the spreader's own width, and thanks to smooth movement of the spreading plate there is no risk of causing damage to the objects around (parked cars, buildings etc.). Spreading speed can be adjusted steplessly with a flow divider valve.

The spreader is front mounted as standard and can be tilted down so that it can be loaded like a normal bucket. For Avant 200 series a mounting plate which increases tilting angle by 30° is necessary for tilting the spreader to horizontal position. Rear mounting is also possible: on 528/530 and 600 series on a designated rear mounting plate (requires also rear auxiliary hydraulics outlet on the loader); on Avant 700 and 800 series either on the rear mounting plate A441613/A441666 (see page 32), or on the optional hydraulic rear lift A427547/A438490 (page 32). Rear mounting requires the optional rear auxiliary hydraulics outlet on the loader, and with the hydraulic rear lift also the attachment control switch pack for rear mounted attachments. Rear lights are also available as an option.

**Options:**

- A429245 Blocking plate kit for sand & salt spreading, spreader 900
- A429247 Blocking plate kit for sand & salt spreading, spreader 1200
- A429959 Rear lights
- A37315 Mounting plate for 200 series, increases tilting angle by 30°
- A433267 Rear mounting plate 528/530/600 serie

- Pendulum type sand/salt spreader, spreads 200-300 mm wider than the spreader's own width
- **Two models**
- **Adjustable spreading amount and speed**
- **Can spread gravel, sand and salt**
- **Front mounted as standard – rear mounting possible on Avant 528/530 & 600, 700 and 800 series**

Model	900	1200
Spreading width	1000-1100 mm	1400-1500 mm
Volume	215 l	430 l
Total width	940 mm	1320 mm
Length	1140 mm	1140 mm
Height	550 mm	550 mm
Weight	121 kg	194 kg
Product no	A427150	A424325

- A441613 Rear mounting plate 700 series
- A441666 Rear mounting plate 800 series
- A427547 Hydraulic rear lift 700 series
- A438490 Hydraulic rear lift 800 series

Modell	220	225	225LPG	313S	320S	320S+	420	423	520	523	525LPG	528	530	R20	R28	R35	630	635	640	735	745	750	755i	760i	860i	e5	e6	
900																												
1200																												



# Centrifugal sand / salt spreader

Centrifugal sand or salt spreader is the right choice for winter maintenance of large areas. Both the spreading area (2 to 6 meters) and the spreading amount can be adjusted either manually (standard) from the side of the spreader - or electrically from the driver's seat (option). This guarantees fast and efficient spreading.

- **Fast spreading on large areas**
- **Spreading width and amount adjustable: manual adjustment as standard, electric adjustment available as an option**
- **Rear mounting also possible, on 700 and 800 series**

Spreading width	0,8-6 m
Volume	250 l
Max. load	500 kg
Weight	130 kg
Product no., front mount	A21183
Product no., rear mount*	A36523

Rear mounting is also possible on 700 and 800 series, on the optional attachment mounting plate A441613/A441666 (see page 32). It requires the optional auxiliary hydraulics outlet in the rear. If electric spreading amount and width adjustment is fitted, also the optional attachment control switch pack for rear mounted attachments must be installed.



Option:

Electric spreading amount and width adjustment A37301

\* The loader must be equipped with attachment control switch pack (option)

Hook agitator (for fine sand and salt) 65851

Chain vibrator/agitator (for gravel and gravel/salt mix) 66378

220	225	225LPG	313S	320S	320S+	420	423	520	523	525LPG	528	530	R20	R28	R35	630	635	640	735	745	750	755i	760i	860i	e5	e6	







# Towable sand / salt spreader

The towable sand / salt spreader is a very handy and economical attachment for winter maintenance of yards and walkways. Power to the spreader shaft is taken mechanically from the wheels. Wheels are equipped with a clutch which allows transporting without sand spreading. Equipped with a 50 mm trailer coupling.

**ATTENTION!** The loader must be equipped with a trailer coupling (A417323 or A417337)

- Economical spreader, quick to attach on the trailer coupling
- Mechanical power take off from the wheels – no need for rear auxiliary hydraulics
- Includes a durable rain cover to protect from moisture and spillage



Spreading width	1000 mm
Width	1500 mm
Volume	215 l
Weight	55 kg
Operation	Mechanical
Product no	A415430

220	225	225LPG	313S	320S	320S+	420	423	520	523	525LPG	528	530	R20	R28	R35	630	635	640	735	745	750	755i	760i	860i	e5	e6	



Very compatible



Compatible



Incompatible



# Vacuum brush

The vacuum brush is intended mainly for collecting of tree leaves in parks, lawns, yards etc. The powerful vacuum unit sucks the waste first into the vacuum on the bottom of the collector box and then into the box, compacting everything into a tight package. The mouthpiece on the vacuum is equipped with a 1300 mm wide rotary brush which loosens also more compacted and wet leaves and waste. Brush rotation speed can be adjusted steplessly. The collector box (same box as on A37411 Collecting lawn mower 1500) is mounted on top of the vacuum unit. It is equipped with large transparent plastic windows so that you can easily monitor how the box is filling up. The box is emptied by opening the lid (powered by a hydraulic cylinder) from Avant's driver seat and by lifting the boom the collected waste can be tipped into a container, skip etc.

- **Efficient leaf collector**
- **Large volume collector box allows fast collecting**
- **Equipped with Optifloat™-system, works well on uneven surfaces also**
- **Fast and easy floating adjustment with indicator arrows on the Optifloat™**
- **Easy emptying thanks to hydraulic lid opening from Avant's driver seat**



Option:  
Handheld vacuuming tube A431787

Working width	1300 mm
Total width	1590 mm
Collector box volume	800 l
Length	1540 mm
Height	1190 mm
Weight	435 kg
Product no	A428800

220	225	225LPG	313S	320S	320S+	420	423	520	523	525LPG	528	530	R20	R28	R35	630	635	640	735	745	750	755i	760i	860i	e5	e6	

Very compatible      Compatible      Incompatible



## Leguan 50 access platform

Avant and its daughter company Leguan Lifts have joined their forces and created an access platform which is mounted directly into Avant loaders quick attach plate. The result is an inexpensive, handy and easy to use access platform. With the help of this lift Avant's versatility is further increased on the job sites.

The Leguan 50 is mounted directly on to loader's quick attach plate quick attach plate like any other Avant attachment. This makes it fast and easy to mount it on and take it off.

Leguan 50 is designed in accordance with access platform standards and it is CE certified. Safe working load is 200 kg - that is two persons or one person with a considerable amount of equipment and tools.

- An inexpensive access platform with 5 meters working height
- Safe and legal way to do building repairs, painting, light bulb changes etc.
- The maximum allowed load on the basket is 200 kg and you are able to use the lift alone
- Leguan 50 is attached to Avant which makes it easy to set it up in virtually all kinds of terrains
- The Leguan 50 access platform gives even further possibilities to use your Avant on work sites



Max. allowed load	200 kg
Max. working height	5,0 m
Height (with lowered platform)	1900 mm
Width	1300 mm
Weight	435 kg
Product no	A34812

220	225	225LPG	313S	320S	320S+	420	423	520	523	525LPG	528	530	R20	R28	R35	630	635	640	735	745	750	755i	760i	860i	e5	e6

Very compatible
  Compatible
  Incompatible



# Tipping trailer

Avant tipping trailer is available in two models: with carrying capacity of 1200 kg or 1800 kg. Both are equipped with hydraulic tipping. All sides can be removed if necessary. Extra side set is available as an option for the smaller model, on the bigger model it is standard.

Attention: the loader must be equipped with double acting rear auxiliary hydraulics outlet and trailer coupling.

- **Robust and versatile tipping trailers, well suited both for earthmoving and for lighter jobs**
- **All sides can be removed if necessary – giving a completely flat and even bed**
- **Hydraulic tipping on both models**



Model	1200	1800
Max. Load	1200 kg	1800 kg
Width	1125 mm	1350 mm
Length	1710 mm	2240 mm
Tyre size	23x8,50-12	26x12-12
Side height	280 mm	560 mm
Product no	A2949	A21200

Option: Extra side set (A45193) for 1.200 kg model

Modell	220	225	225LPG	313S	320S	320S+	420	423	520	523	525LPG	528	530	R20	R28	R35	630	635	640	735	745	750	755i	760i	860i	e5	e6	
1100																												
1800																												

Very compatible
  Compatible
  Incompatible



## Lawn mower I200

The lawn mower I200 is a robust and efficient mower deck. It is equipped with the Optifloat™ floating system, developed by Avant, which guarantees optimal touch with the ground also on uneven lawns. Two indicator arrows on the quick attach plate make adjustment of the floating very easy: when the mower is on level surface and the arrows meet, Optifloat™ is adjusted correctly. The mower is also equipped with a safety valve which stops the blades when the mower is lifted off the ground. The deck is made of stamped steel. This makes mowing more efficient and the grass clippings don't get stuck on the deck so easily. The mower is mulching type as standard. Side discharge kit is available as an option.

- **Optifloat™ floating system guarantees easy operation and good mowing result also on uneven lawns**
- **Safety valve stops the blades when the mower is lifted off the ground**
- **Thanks to stamped steel deck mowing is more efficient and the deck stays cleaner**

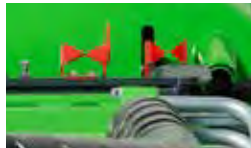

Cutting width	1200 mm
Blades	2 pcs
Cutting height	25 - 100 mm
Weight	170 kg
Product no	A35965

Option: Side discharge kit A36013

220	225	225LPG	313S	320S	320S+	420	423	520	523	525LPG	528	530	R20	R28	R35	630	635	640	735	745	750	755i	760i	860i	e5	e6



Very compatible



Compatible



Incompatible



# Lawn mower 1500

Avant's biggest lawn mower is intended for professional lawn mowing also on larger areas. The mower can be modified to right type of mowing for different circumstances. Powerful mower allows a higher drive speed and perfect cut also on challenging conditions. Optifloat™ system allows large vertical movement of the cutting deck which guarantees efficient cutting as the deck follows the ground contours also on uneven terrains. Two indicator arrows on the quick attach plate make adjustment of the floating very easy: when the mower is on level surface and the arrows meet, Optifloat™ is adjusted correctly. The floating system is also equipped with a safety valve, which stops the blades when the mower is lifted off the ground. The wheels are foam filled, puncture free rubber tyres.

- **Optifloat™ floating system guarantees easy operation and good mowing result also on uneven lawns**
- **More cutting power for challenging mowing conditions**
- **Side discharge as standard, mulching kit available as an option**
- **Rounded edges → less damage to trees, buildings etc. in case of contact**
- **Puncture free, foam filled tires**
- **Fast and easy floating adjustment with indicator arrows on the Optifloat™**



Optional extra: Mulching kit A34530

Cutting width	1500 mm
Blades	3 pcs
Cutting height	25 - 100 mm
Height	450 mm
Weight	285 kg
Product no	A37548

220	225	225LPG	313S	320S	320S+	420	423	520	523	525LPG	528	530	R20	R28	R35	630	635	640	735	745	750	755i	760i	860i	e5	e6	



Very compatible



Compatible



Incompatible



# Collecting lawn mower 1200

With the Avant collecting mower 1200 you can easily do the mowing and collect the clippings. Thanks to its excellent suction power collecting of leaves from the lawns is also possible. The mulching blades of the mower crush the grass clippings, leaves etc. into a very fine material which then moves to the collector and forms a tight and compact package. The cutting waste is ideal material for composting. Collector capacity is as big as 210 litres, which enables cutting of small to medium sized areas. Emptying of the collector is very easy: lift the mower up from the ground with Avant's boom and then tilt the mower downward so much that the grass waste pushes the lid open and the waste comes out. The Optifloat™ floating system, developed by Avant, guarantees optimal touch with the ground also on uneven lawns. Two indicator arrows on the quick attach plate make adjustment of the floating very easy: when the mower is on level surface and the arrows meet, Optifloat™ is adjusted correctly.



Option: Mounting plate for 200 series, increases tipping angle by 30° A37315

220	225	225LPG	313S	320S	320S+	420	423	520	523	525LPG	528	530	R20	R28	R35	630	635	640	735	745	750	755i	760i	860i	e5	e6	

- **Powerful mower with a collector unit**
- **Can also be used for collecting tree leaves on lawns**
- **Vacuum fan can be turned off and the unit can be used as a mulching mower only**
- **Automatic collector box lid opening, by tilting the mower downward**
- **Optifloat™ floating system guarantees easy operation and good mowing result also on uneven lawns**

Cutting width	1200 mm
Blades	2 pcs
Cutting height	25 - 100 mm
Collector box volume	210 l
Product no	A35973

Very compatible
  Compatible
  Incompatible



## Collecting lawn mower 1500

Collecting mower designed for professional use with 1500 mm cutting width and 800 liter collector box. The high suction power makes it also possible to collect tree leaves on lawns. The blades cut the grass, tree leaves etc. to a fine mulch which packs tightly into the collector box.

Collector box volume is designed to be large enough for professional use also in larger areas. Lid opening is hydraulic and operated from Avant's driver seat. By lifting the loader boom and tilting the mower forward the collector box can be emptied into a container, skip etc. Collector box is pivoted in the front and can be tilted forward for easier maintenance. Two indicator arrows on the Optifloat™ quick attach plate make adjustment of the floating very easy. The wheels are foam filled, puncture free rubber tyres.



- Equipped with Optifloat™ – system
- More cutting power for challenging mowing conditions
- Vacuum fan can be turned off and the unit can be used as a mulching mower only
- Rounded edges → less damage to trees, buildings etc. in case of contact
- Puncture free, foam filled tires
- Fast and easy floating adjustment with indicator arrows on the Optifloat™



Optional extras: Mulching kit (complete assembly kit) A34530

Cutting width	1500 mm
Height	1100 mm
Blades	3 pcs
Cutting height	25 - 100 mm
Collector box volume	800 l
Product no	A37411

The optional Opticontrol is recommended on the loader.

220	225	225LPG	313S	320S	320S+	420	423	520	523	525LPG	528	530	R20	R28	R35	630	635	640	735	745	750	755i	760i	860i	e5	e6



Very compatible



Compatible



Incompatible





# Cutting bar

An uncomplicated cutting bar for mowing of hay, grass and trimming of bushes and hedges. Thanks to the side mounting and angle adjustment below ground level mowing of slopes is also possible. Guide plates under the bar support the cutting blades when mowing.

Spring loaded release mechanism allows the bar to move backwards if it hits an obstacle. Cutting angle can be adjusted manually with the hand winch. Electric cutting angle adjustment is available as an option.



- **Robust and economical long hay cutter and hedge trimmer**
- **Cutting angle adjustment below ground level - mowing of slopes also possible**
- **Spring loaded release mechanism for increased safety - cutting bar gives in when hitting an obstacle**
- **Electric cutting angle adjustment available as an option**

Cutting width	1450 mm
Transport width	2540 mm
Transport height	1765 mm
Weight	100 kg
Product no	A35676

Optional extras: Electric cutting angle adjustment A35975

220	225	225LPG	313S	320S	320S+	420	423	520	523	525LPG	528	530	R20	R28	R35	630	635	640	735	745	750	755i	760i	860i	e5	e6



Very compatible



Compatible



Incompatible



# Flail mower

Flail mower is a drum-type cutter, intended for cutting of long grass, scrub, bush and similar vegetation. It will cut up to 20 mm thick tree branches with ease.

Flail mower is the optimal cutting device for places where you need a lot of cutting power and a rougher cut will do. The most common applications for flail mower are places with taller vegetation like meadows, road banks, yard areas etc.

- Cutting deck design improves cutting result and requires less power from the engine and hydraulics
- Flails are mounted in spiral on the shaft which makes cutting more efficient
- Direct drive: hydraulic motor mounted directly on the shaft
- Floating system allows free vertical movement, and the floating can be set so that the mower can tilt freely forward and backward as well
- Big roller in the rear – better stability and less resistance when mowing
- Long and wide skid shoes on the sides
- Models equipped as standard with hammer type flails – Y and L type flails are available as an option



Optional flail types:

A419931 Y-flails, pair, 16 Pcs/1200 mm mower, 18 Pcs/1350 mm mower, 20 Pcs/1500 mm mower

A420305 L-flails, pair, 16 Pcs/1200 mm mower, 18 Pcs/1350 mm mower, 20 Pcs/1500 mm mower

Cutting width	1200 mm	1350 mm	1500 mm
Total width	1580 mm	1730 mm	1880 mm
Cutting height	25 - 100 mm		
Standard flails type/pcs	hammer 16 pcs	hammer 18 pcs	hammer 20 pcs
Weight	240 kg	260 kg	270 kg
Product no	A36730	A441550	A36015

Modell	220	225	225LPG	313S	320S	320S+	420	423	520	523	525LPG	528	530	R20	R28	R35	630	635	640	735	745	750	755i	760i	860i	e5	e6		
1200																													
1350																													
1500																	*	*	*										



# Flail mower with hydraulic side arm S30

The hydraulic side arm with S30 quick attach system can be fitted with attachments with corresponding S30 bracket, for instance the 1200 mm flail mower. It allows mowing on the right side of the loader. The side arm is equipped with a straight telescopic arm and a tilting jib arm, which allows easy mowing of road banks and gradients as well.

The telescopic arm extends max. 1,0 m hydraulically to the side, which means that the outreach of the 1200 mm flail mower is max. 2,9 m from the center of the loader. The jib arm movement is max. 45° down and 90° up from horizontal position. Telescope and jib arm movement speeds are adjustable. The jib arm floats hydraulically upwards, but not downwards. When working, the attachment which is mounted on the arm (flail mower for example) remains in the position where it raised by an obstacle.

The side arm is equipped with a hydraulic release mechanism, and the hydraulic release pressure can be adjusted and measured. The attachment which is mounted on the side arm will give in backwards when it hits an obstacle. The side arm will come back to normal position as soon as the attachment is tilted downwards.

When fitted with the 1200 mm flail mower, Avant 180 kg side weight kit A49063 is necessary at the other end of the side arm in order to keep the unit in balance. The loader must also be equipped with the optional Opticontrol for operating the flail mower.

The 1200 mm flail mower with S30 quick attach bracket mounts only on the S30 hydraulic side arm A424552. It cannot be mounted on the attachment coupling plate of the loader – and on the other hand the flail mowers A36730 and A36015 cannot be mounted on the hydraulic side arm.

- Easy mowing of road banks and gradients with the flail mower
- Outreach to the side max. 2,9 m
- Equipped with high flow hydraulic motor
- S30 quick attach system

Max. outreach to the side	2900 mm
Working width	1200 mm
Weight	680 kg (incl. 180 kg side weights A49063)

Product	Product no.
Flail mower with hydraulic side arm, includes:	A37213
* Flail mower 1200, S30 quick attach system	A37505
* Hydraulic side arm, S30 quick attach system	A424552
* Side weight kit 180 kg, mounts on the side arm	A49063

The optional Opticontrol is required on the loader.

220	225	225LPG	313S	320S	320S+	420	423	520	523	525LPG	528	530	R20	R28	R35	630	635	640	735	745	750	755i	760i	860i	e5	e6	
																*		*	*								

# Hydraulic side arm S30

The hydraulic side arm with S30 quick attach system can be equipped with attachments with the corresponding S30 quick attach bracket.

The side arm is equipped with a straight telescopic arm and a tilting jib arm. The telescopic arm extends max. 1,0 m hydraulically to the side, and the jib arm movement is max. 45° down and 90° up from horizontal position.

The side arm is equipped with a hydraulic release mechanism, and the hydraulic release pressure can be adjusted and measured. The attachment which is mounted on the side arm will give in backwards when it hits an obstacle. The side arm will come back to normal position as soon as the attachment is tilted downwards.

Avant 180 kg side weight kit A49063 is available as an option. It is necessary with heavier attachments like the A37505 S30 flail mower 1200 mm.

- Hydraulic hoses of the attachment are connected to the side arm with flat face quick couplers
- Telescope and jib arm movement speeds are adjustable
- The jib arm floats hydraulically upwards, but not downwards. When working, the attachment which is mounted on the arm (flail mower for example) remains in the position where it raised by an obstacle

Max attachment weight	500 kg
Telescoping to the side	max. 1000 mm
Max width	1870-2580 mm
Jib arm movement	135°
Weight	250 kg
Product no	A424552

The optional Opticontrol is required on the loader.



220	225	225LPG	313S	320S	320S+	420	423	520	523	525LPG	528	530	R20	R28	R35	630	635	640	735	745	750	755i	760i	860i	e5	e6	

Very compatible
  Compatible
  Incompatible

# Mechanical side arm S30

The mechanical side arm with the S30 quick attach system can be fitted with lighter (max. 200 kg) attachments like the A430938 S30 cutting bar and the A429926 S30 multi function drive unit with HD brushes. It is equipped with a mechanical, manually extendable straight telescopic arm and a hydraulic jib arm which tilts the attachment up and down. Telescoping to the side is max. 1000 mm and jib arm movement is max 45° down and 90° up from horizontal position.

The side arm is pivoted in the middle, locked with a pin, and can be turned manually up and down with 45° steps – and even 180° to the other side, which makes it possible to work either on the right or on the left side of the loader. The arm is rigid to all directions, there is no release mechanism in case it hits an obstacle.

- Versatile side arm, can be fitted with hedge cutter bar, weed brushes etc.
- Equipped with a mechanical, manually extendable straight telescopic arm and a hydraulic jib arm
- Telescoping to the side max. 1000 mm, jib boom movement max 45° down and 90° up from horizontal position

Max attachment weight	200 kg
Telescoping to the side	max. 1000 mm
Max width	1645 mm
Jib arm movement	135°
Weight	130 kg
Product no	A431070

The optional Opticontrol is required on the loader.



220	225	225LPG	313S	320S	320S+	420	423	520	523	525LPG	528	530	R20	R28	R35	630	635	640	735	745	750	755i	760i	860i	e5	e6	

Very compatible
  Compatible
  Incompatible

# Attachments for S30 side arms

## Flail mower S30

The 1200 mm flail mower with S30 quick attach bracket mounts only on the hydraulic side arm A424552. It cannot be mounted on the attachment coupling plate of the loader or on the A431070 S30 mechanical side arm - and on the other hand the normal flail mowers A36730 and A36015 cannot be mounted on the hydraulic side arm. The S30 mower has otherwise the same 1200 mm mower deck with hammer flails as the A36730 flail mower, but it is equipped with the high flow hydraulic motor of the 1500 mm flail mower. This gives 25 % higher efficiency/working width ratio than on the 1500 mm flail mower, and 100 % higher than on the standard A36730 1200 mm flail mower.

Working width	1200 mm
Max. width	1580 mm
Weight	250 kg
Product no	A37505



## Cutting bar S30

There are two models of cutting bars which mount on the side arms with S30 quick attach system (both on the mechanical & hydraulic side arm). They cannot be mounted on the attachment coupling plate of the loader. The A430938 cutting bar is equipped with the same cutting blades and blade guides as the A35676 cutting bar. The frame and actuator mechanism are however stronger, which means the A430938 bar is optimized for hedge cutting and doesn't work too well with hay because of the higher frame. There are wear plates at each end of the cutting bar, useful when working on paved and asphalt surfaces for instance.

The A434613 cutting bar with double knives is a more precise hedge cutter and makes a cleaner cut thanks to the double knife design which cuts the branches by sawing them.

The mounting bracket of the cutting bars is pivoted and locked with a bolt, and can be turned manually in different positions. This gives the possibility to for instance cut the hedge horizontally, vertically and in different angles. The cutting bars are also equipped with a pressure relief valve which protects the unit if it hits an obstacle.

Working width	1500 mm	1500 mm
Total width	1600 mm	1790 mm
Weight	90 kg	58 kg
Product no	A430938	A434613



**New**

Groundcare



# Rotary hedge cutter S30

Rotary hedge cutter S30 is an efficient attachment for cutting of shrub, bush, hedge and similar vegetation. It is equipped with three rotors with 4 cutting blades on each rotor. The blades are mounted in two different heights 2+2 on the rotor which – together with the outside rotors rotating inwards - means that they mulch the material into small bits which don't need to be collected after cutting. The rotary hedge cutter can be mounted both on the A431070 mechanical side arm and on the A424552 hydraulic side arm. With Avant 600 series the optional 180 kg rear side weights A49063 are recommended on the loader for better stability.

- **Efficient hedge cutter on S30 side arms, works both in horizontal and vertical position**
- **Equipped with three rotors with 4 cutting blades each**
- **Mulches the material into small bits – cutting waste doesn't need to be collected**



Working width	1300 mm
Total width	1470 mm
Cutting height	25 - 100 mm
Blades	12 pcs (4 pcs/rotor)
Length	1025 mm
Height	385 mm
Weight	200 kg
Product no.	A435550

220	225	225LPG	313S	320S	320S+	420	423	520	523	525LPG	528	530	R20	R28	R35	630	635	640	735	745	750	755i	760i	860i	e5	e6	

# Attachments for S30 side arms

## Multi function drive unit S30

The multi function drive unit equipped with the S30 quick attach bracket is intended mainly for rotating different types of brushes – XL weed brush, XL wire rope brush and carousel broom. It can be mounted in horizontal or vertical position on the side arms with S30 quick attach system (both mechanical and hydraulic arm), but not on the attachment coupling plate of the loader. The S30 drive unit has the same 57 mm square shaft for attachments as the A37190 Multi function drive unit, but is equipped with a lower torque and higher speed hydraulic motor and works therefore better with brushes. On the other hand it doesn't have enough power to rotate auger drills or screw cone log splitter.

- Drive unit which mounts on S30 side arms
- Possible to mount in horizontal or vertical position
- Equipped with high speed hydraulic motor, intended for rotating different types of brushes
- Same 57 mm square shaft for attachments as on the A37190 Multi function drive unit

Groundcare



Torque	950 Nm @ 200 bar
Rotation speed	95 rpm @ 30 l/min
Weight	30 kg
Product no	A429926



- A37317** Carousel broom
- Same Ø 1000 mm replaceable brush as on A2971 Carousel broom, part no. A32698
  - Weight 67 kg



- A433646** Carousel broom, steel
- Ø 1000 mm brush with steel bristles
  - Weight 67 kg



- A429932** XL weed brush
- Consists of 3 pcs Ø 600 mm steel brushes mounted together
  - Max. diameter 1240 mm
  - Height 375 mm
  - Weight 64 kg



- A431157** XL wire rope brush
- Brush with 32 pcs heavy duty wire rope bundles
  - Max. diameter 990 mm
  - Height 370 mm
  - Weight 36 kg

220	225	225LPG	313S	320S	320S+	420	423	520	523	525LPG	528	530	R20	R28	R35	630	635	640	735	745	750	755i	760i	860i	e5	e6	



Very compatible



Compatible



Incompatible



# Edge trimmer

Avant edge trimmer is the perfect attachment for trimming the edges of lawns, hedges, flower beds etc. It consists of a hydraulically operated trimmer mounted next to a cutting disc. Cutting disc cuts lawn precisely where you want and hydraulic trimmer breaks up any soil or lawn that is left to the side of the cutting disc. Edge trimmer leaves a good looking finish to any garden thanks to its adjustable cutting depth and precise control. The edge trimmer is equipped with manually extendable arm and can be turned in three different positions: to the right side or to the left side, or to the front = transport position. Support wheel is available as an option.

- Cuts the lawn edge accurately, leaving a finished look on lawns, flower beds, driveways, walkways etc.
- Hydraulic trimmer mills the soil efficiently
- Equipped with manually extendable arm
- Can be turned manually in three positions: to the left or to the right side, and to center transport position
- Support wheel available as an option



Option: Support wheel A36699

Cutting depth	max. 150 mm
Cutting disc diameter	460 mm
Cultivating width	155 mm
Height	580 mm
Weight	80 kg
Min. width in working position	1080 mm
Product no	A36621

220	225	225LPG	313S	320S	320S+	420	423	520	523	525LPG	528	530	R20	R28	R35	630	635	640	735	745	750	755i	760i	860i	e5	e6





# Lawn aerator

Lawn aerator is designed to create holes in the lawn surface which encourages free movement of soil. This helps to improve the circulation of air in the soil which is vital for a healthy lawn. Avont aerator is completely mechanical – when driving forward with the loader the knife type blades on the aerator shaft turn and make holes in the lawn.

The aerator is equipped with 12 rows of blades with 10 blades each, altogether 120 pcs. Working width is 1500 mm; working height can be adjusted with the nylon spacers on the four support wheels. The aerator is also equipped with mechanical support legs which lift the deck and blades off the ground for storage.

- **Easy and efficient lawn aerating by driving forward with Avont**
- **Equipped with knife type blades**
- **Two Avont 29 kg back weights can be mounted on the sides to add weight**



Working width	1500 mm
Total width	1860 mm
Length	1700 mm
Height	805 mm
Number of blades	120 pcs
Weight	570 kg
Product no.	A424201

220	225	225LPG	313S	320S	320S+	420	423	520	523	525LPG	528	530	R20	R28	R35	630	635	640	735	745	750	755i	760i	860i	e5	e6	



Very compatible



Compatible



Incompatible



# Weed brush

Weed brush is an efficient tool for removal of weeds on all kinds of paved areas etc. It is equipped with a steel brush which can be extended manually and turned in three different positions: to the front, to the right side or to the left side. The weed brush is equipped with a support wheel as standard. It can be lifted and locked up to transport position if needed.

- **Efficient weed removal with rotating steel brush**
- **Equipped with manually extendable arm**
- **Can be turned manually in three positions: to the left or to the right side, and to center transport position**
- **Support wheel as standard**



Brush diameter	600 mm
Bristle material	steel
Height	530 mm
Length/Width (retracted)	1100 mm
Weight	85 kg
Product no	A36594

Option:  
Heavy duty wire rope brush A422665

220	225	225LPG	313S	320S	320S+	420	423	520	523	525LPG	528	530	R20	R28	R35	630	635	640	735	745	750	755i	760i	860i	e5	e6





# Rotary hoe series 2

Rotary hoe is the right attachment for soil cultivating, seed bed finishing and rotovating. It features direct drive with hydraulic motor mounted directly on the milling shaft. The curved blades guarantee efficient milling of the soil. A vertical grading rake with strong tines in front of the blades traps stones and debris, effectively allowing soil to bury them. This gives a finished seeding bed in a single pass. There is also an adjustable soil scraper blade between the milling shaft and the field roller. Working depth is steplessly adjustable with the rear field roller, up to 150 mm.

- **Efficient rotary hoe for soil cultivating, two models**
- **Direct drive with hydraulic motor mounted directly on the milling shaft**
- **Vertical grading rake with strong tines in front of the blades which traps stones and debris**
- **Working depth steplessly adjustable with the rear field roller**
- **Adjustable soil scraper blade between the milling shaft and the field roller**



Working width	1200 mm	1500 mm
Working depth	0 - 150 mm	
Roller width	1400 mm	1700 mm
Total width	1530 mm	1830 mm
Length	1140 mm	1140 mm
Height	550 mm	550 mm
Weight	250 kg	285 kg
Product no	A425119	A37430

Modell	220	225	225LPG	313S	320S	320S+	420	423	520	523	525LPG	528	530	R20	R28	R35	630	635	640	735	745	750	755i	760i	860i	e5	e6	
1200																												
1500																												

**New**



# Power rake

Power rake is a versatile attachment for soil grading, levelling, raking, and removing of debris. It can be used, for instance, for preparing seedbeds, cutting grades, grading dirt and gravel roads, and cleaning up and grading different types of sites.

Power rake mills the soil to max. 65 mm depth. The shaft is equipped with steel teeth. Driving direction is forwards and the shaft rotates against the driving direction. The removable side plates make soil moving and directioning even more efficient. The rake is equipped with two adjustable support wheels and it can be turned to max. +/- 30 degrees angle.

Two models available: with manual or hydraulic turning.

- Versatile attachment for preparing seedbeds, grading dirt and gravel roads, cleaning up building lots and sites etc.
- Easy removal and piling up of rocks and other debris by driving forward
- Available with manual or hydraulic turning, +/- 30 degrees



Working width	1480 mm
Total width	1773 mm
Working depth	max. 65 mm
Turning angle	+/- 30°
Length	1210 mm
Height	670 mm
Weight	315 kg
Product no., manual turning	A434016
Product no., hydraulic turning	A439234

220	225	225LPG	313S	320S	320S+	420	423	520	523	525LPG	528	530	R20	R28	R35	630	635	640	735	745	750	755i	760i	860i	e5	e6	



Compatible



Adaptable



Incompatible



# Rotary harrow

Avant rotary harrow is an excellent leveler for lawn beds, yards, gardens etc. – for places where the ground needs to be perfectly levelled. It harrows only the topsoil and gives a very nice finish for sowing. Required output is lower than that of the rotary hoe, which allows also a higher working speed. Working depth is adjusted with the rear field roller which levels the seeding bed during operation. With the optional seeding unit you are able to make a ready lawn surface on one pass.

Rotary harrows are most commonly used for lighter topsoil levelling. The soil is normally not milled as deep or as thoroughly as with a rotary hoe.

- Professional, efficient rotary harrow for topsoil levelling
- Top grade finish with just one pass
- Can be equipped with seeding unit → ready lawn surface in a single pass
- Requires less power than rotary hoe



Optional extras:

- Seeding unit for 1350 mm model (A21085)
- Seeding unit for 1500 mm model (A21193)
- Seeding unit for 1700 mm model (A415800)

Model	1200	1350	1500	1700
Working width	1050 mm	1220 mm	1400 mm	1550 mm
Roller width	1200 mm	1350 mm	1500 mm	1700 mm
Working depth	0-160 mm			
Weight	180 kg	220 kg	250 kg	280 kg
Weight with seeding unit	-	260 kg	290 kg	320 kg
Product no	A21067	A21077	A21185	A21431

Modell	220	225	225LPG	313S	320S	320S+	420	423	520	523	525LPG	528	530	R20	R28	R35	630	635	640	735	745	750	755i	760i	860i	e5	e6		
1200																													
1350																													
1500																													
1700																	*	*	*										



# Leveller

A simple and inexpensive but incredibly useful and efficient attachment for levelling and planing of larger areas. With Avant leveller you can easily and quickly level sand, mulch etc. The leveller is most commonly used in:

- Preliminary lawn bed levelling
- Yard sand levelling
- Driveway levelling

The leveller can also be used for lifting job site materials like sod rolls, tools etc.

- **Economical attachment for levelling gravel and other soil materials**
- **Eliminates almost all manual shoveling at job sites**



Width	Weight	Product no
1200 mm	85 kg	A3241 I
1500 mm	95 kg	A33537

220	225	225LPG	313S	320S	320S+	420	423	520	523	525LPG	528	530	R20	R28	R35	630	635	640	735	745	750	755i	760i	860i	e5	e6	





# Leveller HD

The HD leveller is an incredibly useful and efficient attachment for quick levelling of uneven ground, mulch, yards, driveways etc. It is most commonly used in:

- preliminary lawn bed levelling
- yard and driveway sand and gravel levelling
- levelling of uneven ground

The leveller can also be used for lifting job site materials like sod rolls, tools etc.



- **Bucket cutting edge in the front and in the rear, allows breaking and cutting of the ground**
- **Straight vertical levelling edge in the rear**
- **Grate at the front, for picking up stones**
- **Two hook type brackets in the front, for transporting a bucket etc.**
- **Scarifier bar in the rear, equipped with hooks. It can be turned manually in 5 different working depths, and can also be lifted up so that the leveller works without scarifying**

Working width	1600 mm
Total width	1630 mm
Length	1050 mm
Working depth	max. 100 mm
Weight	172 kg
Product no.	A427450

220	225	225LPG	313S	320S	320S+	420	423	520	523	525LPG	528	530	R20	R28	R35	630	635	640	735	745	750	755i	760i	860i	e5	e6	

Very compatible
  Compatible
  Incompatible



# Roller compactor

The roller compactor with mesh roller is a practical attachment for compacting soil when preparing for lawn seeding and right after lawn seeding. You are able to compact soil with the full 1500 mm width of the roller and push down with the whole weight of the loader's front axle.

The other roller compactor model is equipped with a plain, hollow roller which can be filled with water (max. 167 l). It is useful for preparing and compacting a newly installed sod and similar surfaces where a plain roller is a must and mesh rollers cannot be used. Both compactors can also be fitted with max. 4 pcs of Avant 29 kg back weights. The compactors can also be towed, if needed, with the A3748I drawbar mounted on the compactor.

- **Easy and economical compacting of lawns before and after seeding with the mesh roller**
- **Plain roller is useful for compacting a newly installed sod and similar surfaces; can be filled with water**
- **Both models can also be towed with the A3748I drawbar**
- **4 pcs Avant 29 kg back weights can be mounted to add weight**



Model	Mesh roller	Plain roller
Working width	1500 mm	1500 mm
Total width	1605 mm	1605 mm
Roller diameter	400 mm	406 mm
Length	610 mm	610 mm
Weight, without extra weights and water	100 kg	196 kg
Water volume	-	167 l
Product no	A37064	A37488

220	225	225LPG	313S	320S	320S+	420	423	520	523	525LPG	528	530	R20	R28	R35	630	635	640	735	745	750	755i	760i	860i	e5	e6	





# Front rake

Front rake is an uncomplicated and economical attachment for levelling of sand and gravel driveways, anywhere you want to have a nice looking finish. The spring loaded tines rake and level the ground efficiently. The rake can also be used for loosening and levelling of uneven soils.

There are two models available: one with normal tines and other with HD tines. The rake with stronger HD tines will also collect branches etc. heavier material when levelling the ground.

- **Uncomplicated and economical leveller for sand and gravel driveways**
- **Works on soils as well**
- **Two models available: with normal tines or with stronger HD tines**
- **Can be mounted on all Avant models**



Model	Standard	HD
Width	2000 mm	2000 mm
Tine height	245 mm	420 mm
Total height	560 mm	695 mm
Weight	35 kg	56 kg
Product no	A36968	A37357

220	225	225LPG	313S	320S	320S+	420	423	520	523	525LPG	528	530	R20	R28	R35	630	635	640	735	745	750	755i	760i	860i	e5	e6	

Very compatible
  Compatible
  Incompatible



# Ripper

The ripper is an inexpensive and practically irreplaceable tool in ground works. With the ripper it is easy and effortless to remove roots as well as rocks even from hard packed ground. The replaceable hard metal teeth guarantee a long lifespan for the attachment.

The ripper is operated by pressing the three blades into the ground next to the object you wish to remove. When the teeth have sunk into the ground, tilt the ripper inwards and then lift the boom upwards which will bring the object on top of the ground.

- **An inexpensive tool for removing of rocks, tree stumps, roots etc. from the ground**
- **Eliminates a huge amount of manual work**



Width	500 mm
Working depth	appr. 300 mm
Weight	50 kg
Product no	A44412

220	225	225LPG	313S	320S	320S+	420	423	520	523	525LPG	528	530	R20	R28	R35	630	635	640	735	745	750	755i	760i	860i	e5	e6	

**New**

**Landscaping**



# Mulcher CRI400

Mulcher CRI400 is a heavy duty soil conditioner and vegetation remover. It clears vegetation and undergrowth and can crush small roots and tree stumps as well. This makes the mulcher a useful tool for clearing the soil and also for preparing it for seeding and planting. The rotor is equipped with replaceable carbide cutting teeth. Support skids are standard equipment as well. They are pivoted which means they follow the contours of the cultivated surface, allowing very easy and accurate working depth adjustment. The mulcher can also be used for removal of ice and hard packed snow on pavements, parking lots etc.

- **Heavy duty soil conditioner - can crush smaller roots, tree stumps and branches as well**
- **Rotor with carbide cutting teeth**
- **Hardox steel frame**
- **Bolt mounted counter blades**
- **Support skids as standard**
- **Possibility to turn the direction of the rotor**



Total width	1750 mm
Rotor width	1350 mm
Rotor diameter	400 mm
Working depth	0 - 200 mm
Height	670 mm
Weight	540 kg
Product no	A436164

220	225	225LPG	313S	320S	320S+	420	423	520	523	525LPG	528	530	R20	R28	R35	630	635	640	735	745	750	755i	760i	860i	e5	e6



Very compatible



Compatible



Incompatible



## Screening bucket

The Avant screening bucket is a fast and efficient compact system for screening and blending soils, aggregates and compost. The durable and flexible star-shaped plastic Poly Star rollers screen without shredding the vegetation or crushing the aggregates into the finished screened product.

The unique design fitted with sealed bearings, self tensioning carbon belt driveline and flexible Poly Stars enables for a large screening area to create a low maintenance, fast and efficient screening system.

- **Separates stone/soil/vegetation**
- **Screens without crushing or shredding**
- **Suitable for different types of soil**



Width	1410 mm
Bucket volume	258 l
Screening area	1200 x 430 mm
Weight	390 kg
Product no	A36503

220	225	225LPG	313S	320S	320S+	420	423	520	523	525LPG	528	530	R20	R28	R35	630	635	640	735	745	750	755i	760i	860i	e5	e6	





# Stump grinder

Avant stump grinder is an efficient and easy to operate tree stump remover. The cutting disc is mounted crosswise in relation to the loader, which means it throws the wood waste to the right side – the waste doesn't fly on the operator or the loader. In addition, the stump grinder is equipped with a protective rubber cover which prevents the wood from flying around.

Grinding happens by moving the grinder forward and backward which means easy control with the drive pedals of the loader – or with the tilt movement of the quick attach plate, and the sideways mounting of the cutting disc guarantees excellent visibility to the working area. Cutting teeth have three cutting edges: once a tooth becomes blunt, its fastening bolt is easy to open and turn the tooth so that a sharp cutting edge comes into use.

- Equipped with  $\varnothing$  540 mm cutting disc with 20 pcs replaceable teeth
- Teeth have three cutting edges – once a tooth becomes blunt it can be turned to get a new sharp cutting edge
- Excellent visibility to the work area, easy to operate
- Rubber damper on the quick attach bracket minimizes vibrations to the loader and makes working smoother



Cutting disc diameter	540 mm
Number of teeth	20 pcs
Width	840 mm
Height	920 mm
Length	630 mm
Weight	175 kg
Product no	A438282

220	225	225LPG	313S	320S	320S+	420	423	520	523	525LPG	528	530	R20	R28	R35	630	635	640	735	745	750	755i	760i	860i	e5	e6

Very compatible
  Compatible
  Incompatible

**New**

Landscaping



# Mounting kit for stone installation clamp

For professional paving, a hydraulic stone installation clamp is a fast and easy way to lay paving stones. The installation clamp takes a whole layer of stones from the pallet, which then can be lifted directly to the area to be paved. Avant is an ideal machine for this job thanks to the articulated chassis which allows driving on the paved surfaces without damaging them, and thanks to the rigid articulation joint Avant loader is very stable also in paving jobs.

With the mounting kit it is easy to install on Avant loader practically any hydraulic stone installation clamp available from renowned manufacturers (Hunklinger, Optimas, Probst for example). The mounting kit is a complete "plug and play" kit which includes lifting boom, hydraulic rotator with continuous 360° rotation and electrically controlled hydraulics.

The stone installation clamp is mounted on the shaft of the mounting kit's hydraulic rotator and the clamp's hydraulic hoses are connected in the ports on the rotator. All functions of the stone installation clamp (rear/front grabbers, side grabbers, rotation) are operated with the Opticontrol attachment control system on the loader. Because the mounting kit already includes the rotator and control valve, they are not needed in the stone installation clamp itself. The mounting kit is CE marked and comes with operating and installing instructions.

- **CE marked "plug and play" mounting kit for hydraulic stone installation clamps**
- **Includes hydraulic rotator and electric control valve**
- **Operated with the Opticontrol attachment control system on Avant loader**

Lift capacity, stone installation clamp + load	800 kg
Weight	66 kg
Product no	A436347

The optional Opticontrol is required on the loader.

220	225	225LPG	313S	320S	320S+	420	423	520	523	525LPG	528	530	R20	R28	R35	630	635	640	735	745	750	755i	760i	860i	e5	e6

**New**



# Stone grab

The stone grab, equipped with rotator, allows grabbing, transporting and loading of different types of stones both lengthwise and crosswise. This makes it possible to pass through narrow places also with long kerb stones and enables loading in any direction. The grab is available either with a hydraulic rotator or as freely rotating version. Padded stone grabbers are available as an option. They allow grabbing the stone by pressing it. Stone grabbers come with a lock valve which prevents unintentional opening of the grab. If the loader is equipped with the 6 or 8 function joystick, all functions of the grab with hydraulic rotator (grab opening/closing, rotation) can be operated with the switches on the optional Opticontrol switch pack.

- Available with hydraulic rotator or as freely rotating version
- Can be equipped with padded stone grabbers



Option:  
 Lock valve, mounting kit, on grab cylinder A436627  
 Padded stone grabbers (kit includes lock valve) A429742

Rotation type	Freely rotating	Hydraulic rotation
Grapple opening diameter	1223 mm	1223 mm
Weight	116 kg	136 kg
Product no	A37457	A37456

The optional Opticontrol is recommended with grab with hydraulic rotator, for operating the grab opening/closing and rotation (requires also 6 or 8 function joystick on the loader).

220	225	225LPG	313S	320S	320S+	420	423	520	523	525LPG	528	530	R20	R28	R35	630	635	640	735	745	750	755i	760i	860i	e5	e6



# Grabbing tool

Grabbing tool is mainly intended for lifting and handling of round objects. It is especially suited for lifting of barrels and plant and tree pots. Grabbing force can be adjusted, which means all kinds of objects can be handled without damaging them.

Grabbing tool is equipped with two smaller, rubber padded grabs which allow handling of smaller and more fragile objects as well. When the grab is opened completely it can take larger objects like barrels, bigger plant pots etc.

- **Easiest way to lift and transport plants, trees, barrels etc. without damaging them**
- **Excellent tool for nurseries and landscapers**
- **With the optional tilt adapter or attachment rotator mounted on the grabbing tool it is also possible to rotate the objects**



Option: Conical grabbers – for objects with conical shape like plant pots A421030

Barrel grabbers – for completely round objects like barrels A421031

Tilt adapter 90 degrees A36505

Attachment rotator A424406

(requires second auxiliary hydraulics outlet in the front)

Min. grab diameter	250 mm
Max. grab diameter	1200 mm
Max. load	650 kg
Weight	95 kg
Product no	A34290

220	225	225LPG	313S	320S	320S+	420	423	520	523	525LPG	528	530	R20	R28	R35	630	635	640	735	745	750	755i	760i	860i	e5	e6	

Very compatible
  Compatible
  Incompatible





# Backhoe 170

Avant backhoe 170 is a compact digging unit, intended mainly for Avant 200 series. The main focus in design was user friendliness and straight forward construction. Backhoe 170 is a small backhoe, which is at its best in tight situations where space is limited. Boom movements are smooth and precise, which makes operation easier also for less experienced users. To facilitate the digging the frame of the backhoe is as low as possible, which gives unrestricted visibility to the work area.

- An uncomplicated, strong and compact backhoe
- Easy to connect and disconnect to Avant
- Smooth movements with precise control valve, easy to operate

Max. Digging depth	1 700 mm
Standard bucket	250 mm
Weight	180 kg
Product no	A36848

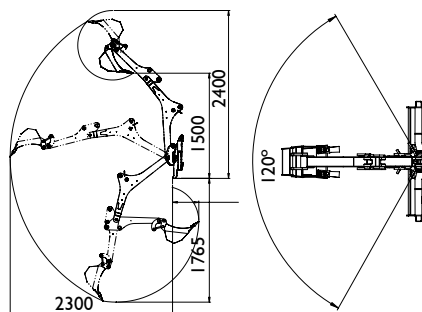

Optional extras:  
 Bucket 400 mm A415230  
 Bucket 750 mm A35564

220	225	225LPG	313S	320S	320S+	420	423	520	523	525LPG	528	530	R20	R28	R35	630	635	640	735	745	750	755i	760i	860i	e5	e6



# Backhoe 210

Avant backhoe 210 designs main focus was user friendliness and straight forward construction. Backhoe 210 is slightly larger than its smaller sister backhoe 170, which makes it more versatile and gives more digging depth.

Boom movement speeds are steplessly adjustable, which makes operation easier also for inexperienced users.

To facilitate the digging the frame of the backhoe is as low as possible, which gives unrestricted visibility to the work area.

- **A powerful, strong and compact backhoe**
- **Easy to connect and disconnect to Avant**
- **Smooth movements with precise control valve, easy to operate**
- **Uncomplicated and economical backhoe**

Max. Digging depth	2100 mm
Standard bucket	400 mm (A415230)
Weight	230 kg
Product no	A33747

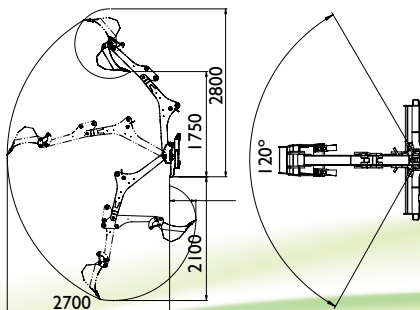

Optional extras:

Bucket 250 mm A415232

Bucket 750 mm A35564

220	225	225LPG	313S	320S	320S+	420	423	520	523	525LPG	528	530	R20	R28	R35	630	635	640	735	745	750	755i	760i	860i	e5	e6

**Renewed**

**Digging and construction**



# Backhoe 260

Backhoe 260 has many improved features: Boom swing happens with two hydraulic cylinders, instead of the single cylinder and chain drive in the old models. The new system gives more exact boom movements when swinging and requires less service. Swing angle is 170 degrees. Backhoe 260 is equipped with hydraulic outriggers as standard. The operator can easily adjust the outriggers with the lever on the backhoe control valve. This allows quick and easy set up also on uneven terrains. Changing of bucket is easy thanks to the quick attach mechanism. Mounting the backhoe on Avant is very fast, and the new foldable control valve bank and locking system on the boom make it even easier.

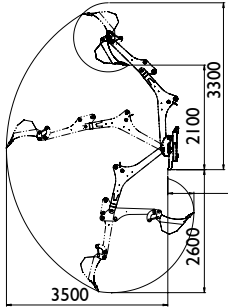

Optional extras:

- Bucket 250 mm A414301
- Bucket 750 mm A35230
- Bucket 1000 mm A35383
- Bucket tilt adapter S30-150 with sideways tilt A35249 (not when thumb grab A435527)
- Trapezoidal bucket 650 mm A21638
- Trapezoidal bucket 912 mm A36374
- Thumb grab A435527 (not when bucket tilt adapter A35249)



- Powerful and professional backhoe with good outreach
- Hydraulic outriggers
- Bucket quick attach system S30-150
- 170 degree boom swing angle with consistent speed
- Dozer blade on front frame
- Several bucket options
- Bucket sideways tilt adapter available as an option
- Thumb grab available as an option, for handling stones etc. objects

Max. Digging depth	2600 mm
Width	1300 mm
Boom swing angle	170 °
Standard bucket	400 mm
Weight	420 kg
Product no	A37510

220	225	225LPG	313S	320S	320S+	420	423	520	523	525LPG	528	530	R20	R28	R35	630	635	640	735	745	750	755i	760i	860i	e5	e6

Very compatible
  Compatible
  Incompatible

**Renewed**



# Backhoe 260 with remote control

Avant backhoe 260 is now available also with radio remote control (remote control cable is also included). It allows the operator to stand next to the unit when digging and have a perfect, unrestricted field of vision to the work area. This is very useful for utility jobs, cemeteries and similar places where space is limited and exceptionally exact digging with total visibility is necessary.

The backhoe is equipped with a proportional control valve which guarantees easy and smooth operation and very exact movements of the booms and bucket with the joysticks of the remote control unit. If necessary, the movements can also be fine tuned. The required safety features like emergency stop, blinking light etc. are also fitted. Range of the radio remote control unit is about 100 m. It is equipped with a rechargeable battery with approx. 11 hour working cycle. Battery charging time is 4 hours. Battery charger is included – a 12V charger or a 80-230V mains current charger.

Backhoe 260 with remote control is a product of its own – the remote control system cannot be retrofitted on a standard backhoe 260.

Optional extras:

- Bucket 250 mm A414301
- Bucket 750 mm A35230
- Bucket 1000 mm A35383
- Bucket tilt adapter S30-150 with sideways tilt A35249 (not when thumb grab A435527)
- Trapezoidal bucket 650 mm A21638
- Trapezoidal bucket 912 mm A36374
- Thumb grab A435527 (not when bucket tilt adapter A35249)



- **Perfect, unrestricted field of vision to the whole digging area**
- **Equipped with proportional control valve => stepless, smooth and exact movements with the joysticks of the remote control unit**
- **Range of remote control about 100 m**
- **Remote control battery is rechargeable, working cycle about 11 hours – charging time 4 hours**

Max. Digging depth	2600 mm
Width	1300 mm
Boom swing angle	170 °
Standard bucket	400 mm
Weight	420 kg
Product no 500-700 series	A433851
Product no 800 series	A440295

220	225	225LPG	313S	320S	320S+	420	423	520	523	525LPG	528	530	R20	R28	R35	630	635	640	735	745	750	755i	760i	860i	e5	e6



# Mini digger

Avant mini digger is an efficient solution for small digging operations where maximum digging depth of 1200 mm or 1500 mm is enough and digging is not an everyday work. It mounts directly on the quick attach plate of the loader and is operated with the auxiliary hydraulics control lever, or with the buttons of the joystick if fitted. Dumping to the side happens by turning the steering wheel of the Avant.

Mini digger 150 is equipped with the S30 bucket quick attach system (same as on backhoe 260), which makes changing of bucket fast and easy - and the bucket can also be mounted pointing forward if necessary. Bucket tilt adapter for mini digger 150 is available as an option.



Option:

Bucket tilt adapter (Mini digger 150) A35320

Model	220	225	225LPG	313S	320S	320S+	420	423	520	523	525LPG	528	530	R20	R28	R35	630	635	640	735	745	750	755i	760i	860i	e5	e6	
120																												
150																												

- **Efficient and economical solution for smaller digging jobs**
- **Very fast to mount on Avant**
- **Simple and light to transport from job site to another**
- **High unloading height**
- **Material can easily be transported further away**
- **Bucket tilt adapter available as an option for mini digger 150**

Model	120	150
Max. digging depth	1200 mm	1500 mm
Standard bucket	250 mm	-
Weight	70 kg	85 kg
Product no	A36822	A36856

Buckets available		
250 mm	A415232	A414301
400 mm	A415230	A414304
750 mm	A35564	A35230
1000 mm	-	A35383
Trapezoidal bucket 650 mm		A21638
Trapezoidal bucket 912 mm		A36374



Very compatible



Compatible



Incompatible



# Auger

Powerful hydraulic auger with many different auger diameters to suit various tasks, be it post hole boring, tree transplanting etc. Standard drive unit has hydraulic motor and direct drive to the auger. Heavy duty drive unit is equipped with planetary drive to increase torque, needed especially in hard ground conditions or when using large diameter augers.

Replaceable tungsten teeth and pilot head are a standard feature in the auger drills. This enables drilling in hard ground as well as in sandstone.

Combination of an articulated Avant and auger offer excellent visibility and minimum ground damage.



- Drill 75 mm A34225
- Drill 100 mm A33601
- Drill 150 mm A33608
- Drill 200 mm A33609
- Drill 225 mm A33610
- Drill 250 mm A33611
- Drill 300 mm A33612
- Drill 350 mm A33613
- Drill 400 mm A33614
- Drill 450 mm A33615

- Drill 500 mm A33616
- Drill 600 mm A33617
- Drill 750 mm A33618
- Drill 900 mm A33619
- Extension 500 mm A33546
- Extension 800 mm A32532
- Extension 1000 mm A33554
- 2 way swing adapter for HD auger drives A421877

- **Wide range of auger drive units with different torques enables efficient use of 75 mm to 900 mm auger drills**
- **The right drive unit for your work depends on the maximum drill diameter needed. Choose the drive unit from the table below**
- **The replaceable tungsten teeth and center pilot on all auger drills ensure long lifespan also on professional day to day use**
- **2 way swing adapter for HD auger drives. Allows the auger and auger drive to swing sideways also, which means that the hole can be drilled straight no matter how the machine is positioned.**

Model	Drills	Torque	Prod. no
Direct drive	75-300 mm	1355 Nm	A37190
HD 45	75-600 mm	2452 Nm	A33552
HD 58	75-750 mm	3017 Nm	A33551
HD 72	75-900 mm	3874 Nm	A34032

Model	220	225	225LPG	313S	320S	320S+	420	423	520	523	525LPG	528	530	R20	R28	R35	630	635	640	735	745	750	755i	760i	860i	e5	e6	
Direct drive																												
HD 45-72																												



# Trencher

With Avat trencher you can easily dig narrow trenches without damaging the ground on the digging area. The trencher does a clean trench which can easily be filled with a bucket or a dozer blade. Planetary drive with hydraulic motor guarantee powerful and trouble free operation.

Digging depths are 900 and 1200 mm respectively, depending on model. Digging width is either 100, 150 or 200 mm, depending on the width of the trenching chain.

Trencher chains have tungsten reinforcements to ensure long lasting performance in all soil conditions.

- Trencher is ideal for smaller cable or pipe laying
- Digging speed with a trencher is 2-3 times quicker compared to a backhoe
- Combination of an articulated Avat and trencher leaves almost no marks of digging operations after the work is done. This makes it a perfect solution for gardens and other lawn areas.

- **Very fast and clean way to dig trenches for cables, drains, piping etc.**
- **Digs only 100-200 mm wide trench and moves all ground to the right side of the trench**
- **Minimal damage to the ground on trenching area**

Digging width	100 mm	150 mm
Digging depth	900 mm	900 mm
Product no	A33555	A33557

Other models (chain width & digging depth) also available, please consult your local Avat distributor.



220	225	225LPG	313S	320S	320S+	420	423	520	523	525LPG	528	530	R20	R28	R35	630	635	640	735	745	750	755i	760i	860i	e5	e6	



Very compatible



Compatible



Incompatible



# Multi function drive unit

The multi function drive unit can be fitted with auger drills and screw pile adapter as always; in addition there are several other attachments available: concrete mixing drum, screw cone log splitter, screening drum, cable/hose reel, carousel broom, rotary hoe, XL weed brush and XL wire rope brush.

There is also a 90 degree angle adapter available as an option, on which the drive unit can be mounted. It turns the the drive unit 90° to the left or right. This means that for instance the carousel broom sweeps on the left/right side of the loader, and the cable/hose reel is crosswise to the loader and winds the cable longitudinally (in parallel to the loader).

- **Torque 1355 Nm**
- **Auger drills and screw pile adapter are mounted on the drive unit like before, in addition following attachments can be fitted: Concrete mixing drum, Screw cone log splitter, Screening drum, Cable/hose reel, Carousel broom, Rotary hoe, Angle adapter 90°, XL weed brush, XL wire rope brush**



Width	550 mm
Height	560 mm
Length	405 mm
Weight	85 kg
Product no	A37190

220	225	225LPG	313S	320S	320S+	420	423	520	523	525LPG	528	530	R20	R28	R35	630	635	640	735	745	750	755i	760i	860i	e5	e6	





# Attachments on multi function drive unit



- A37395 Concrete mixing drum**
- Volume: 140 l water, 90 l ready concrete
  - Length 760 mm
  - Width 600 mm
  - Weight 50 kg



- A37311 Cable/hose reel**
- Inside width 400 mm
  - Total width 558 mm
  - Reel diameter 190 mm
  - End plate diameter 500 mm
  - Weight 25 kg
  - Can also be mounted on the A37323 Angle adapter 90° => winds the cable in parallel to the loader



- A418530 Screw pile adapter**
- Easy way of making screw pile foundations, saves a lot of manual work
  - Mounts on any Avant auger drive unit
  - Fits on Ø 60 mm screw piles



- A37207 Screening drum**
- Intended for screening of soil, gravel and sand
  - Volume: 90 l
  - Screening sieve with 50x50 mm holes – included also a separate 22x22 mm sieve, which is bolted on the drum when finer screening is required
  - Length 605 mm
  - Width 500 mm
  - Height 461 mm
  - Weight 75 kg



- A37500 Screw cone log splitter**
- Log splitter with a conical splitting screw
  - Splitting screw equipped with a replaceable tip
  - Also equipped with a log holder bar which prevents the log from rotating during splitting
  - Weight 30 kg



- A37317 Carousel broom**
- Same Ø 1000 mm replaceable brush as on A2971 Carousel broom, part no. A32698
  - Weight 67 kg
  - Can also be mounted on the A37323 Angle adapter 90° => sweeps on the left side of the loader



- A37491 Rotary hoe**
- For small scale soil cultivating
  - Equipped with two knife type blades
  - Dimensions:
  - Cultivating depth max. 160 mm
  - Length 531 mm
  - Width 156 mm
  - Height 283 mm
  - Weight 15 kg



- A37323 Angle adapter 90°**
- Turns the drive unit 90° to the right or to the left beside the loader
  - Length 630 mm
  - Width 651 mm
  - Height 300 mm
  - Weight 41 kg



- A429932 XL weed brush**
- Efficient weed remover
  - Consists of 3 pcs Ø600 mm steel brushes mounted together
  - Max. diameter 1240 mm
  - Height 375 mm
  - Weight 64 kg



- A433646 Carousel broom, steel**
- Ø 1000 mm brush with steel bristles
  - Weight 67 kg



- A431157 XL wire rope brush**
- Brush with 32 pcs heavy duty wire rope bundles
  - Max. diameter 990 mm
  - Height 370 mm
  - Weight 36 kg



# Hydraulic breaker

Avant breakers are specially designed for use with Avant loaders. From three different models you can find suitable for all 300, 400, 500, 600, 700 and 800 series models.

Avant loader with breaker is a very efficient tool in demolition and refurbishing operations: do the demolition with Avant and breaker, take the debris away with Avant and bucket – very fast and effective. Another benefit of this combination is its compact dimensions: you can go almost anywhere with this unit.

Avant breakers are the fastest, easiest and most efficient breakers for Avant loaders. All hoses, couplings and quick attach brackets are included in the package. In addition to this all set ups have been done to the breaker already at the factory so you can be sure you have a fully functioning package on the worksite.



- **Top quality sound isolated Avant breakers are quiet and powerful**
- **Breakers are pre-adjusted at the factory (oil flow, pressure) to suit Avant loaders**
- **There is a breaker for each Avant model, starting from 300 series**
- **Hydraulic hoses and mounting plate are included in the package – the breaker is all ready for work**

Model	Impact rate (frequency)	Weight	Product no
B105	600-3200 bpm	105 kg	A36423
B155	800-3000 bpm	155 kg	A36424
B230	700-2600 bpm	230 kg	A36425

Modell	220	225	225LPG	313S	320S	320S+	420	423	520	523	525LPG	528	530	R20	R28	R35	630	635	640	735	745	750	755i	760i	860i	e5	e6		
B105																													
B155																													
B230																	*		*	*									

**New**

**Digging and construction**



# Tarbox

An economic attachment for placing Asphalt, Tar or any Screed materials. Ideal for pathways and areas that a placer machine cannot gain access. The AVANT Tarbox is available in 1500 mm width with 200 mm offset to both sides. A width reducing plate allows narrow trenches or strips to be filled. Material depth control is via screw control. The easy to operate TarBox will increase productivity on any job.

- **Fill via Truck chutes**
- **Simple Hydraulic Discharge**
- **Adjustable Strike plate for easy depth control**



Working width	1500 mm
Volume	315 l
Weight	350 kg
Product no	A43886 l

220	225	225LPG	313S	320S	320S+	420	423	520	523	525LPG	528	530	R20	R28	R35	630	635	640	735	745	750	755i	760i	860i	e5	e6

**New**



# Asphalt spreader

Asphalt spreader is an efficient and easy to operate attachment for smaller repairs on roads, pavements, yards etc. It is intended for spreading mastic asphalt (guss asphalt) which is made especially for surface repairs. Therefore the spreader doesn't work with traditional asphalt.

The 700 mm wide asphalt strip is spread by driving forward with the loader. This way the new asphalt surface runs between the wheels of the loader. Hydraulically operated hatch at the bottom of the spreader allows spreading right amount of asphalt to the rear compacting plate which compacts the asphalt - additional compacting with an asphalt roller is not necessary. The unit moves on skid shoes made of Hardox steel.

The required aggregate (sand) spreading on asphalt - to make the new asphalt less slippery - can be done at the same time with the rear mounted Avant sand spreader.



- **Easy and fast asphalt surface repairs on roads, pavements, parking lots etc.**
- **Works with mastic asphalt**
- **Rear compacting plate on the spreader compacts the asphalt, additional finishing with asphalt roller is not necessary**
- **Aggregate spreading can be done at the same time with the rear mounted Avant sand spreader**

Working width	700 mm
Total width	902 mm
Volume	360 l
Length	1050 mm
Height	913 mm
Compaction plate height adjustment	0-40 mm
Weight	240 kg
Product no	A427857

220	225	225LPG	313S	320S	320S+	420	423	520	523	525LPG	528	530	R20	R28	R35	630	635	640	735	745	750	755i	760i	860i	e5	e6	



# Asphalt grinder

The strong and efficient asphalt grinder (also called cold planer) is an ideal attachment for asphalt road and pavement repairs and utility jobs. It grinds away the asphalt surface up to 80 mm depth, making repair of potholes, utility cuts, small overlays and edge repairs fast and easy. Different types of teeth are available for grinding of asphalt or concrete. Water spraying system is available as an option. It is mounted on top of the planer and is equipped with 120 l water tank and nozzle bar (same as on Avant collecting broom), membrane pump and strainer filter. Also, 3 pcs Avant 29 kg counterweights can be mounted on the water tank support frame to add weight when grinding hard asphalt etc. material.

If side shift is needed, the hydraulic side shift adapter A37235 is available as an option. It requires the optional second auxiliary hydraulics front outlet on the loader.

Option: Water spraying system

- Mounts on top of the grinder
- Water tank 120 l + nozzle bar (same as on Avant 1500 mm collecting broom & bucket broom), membrane pump & strainer filter
- Max. 3 pcs Avant 29 kg counterweights A35957 can be mounted on the water tank support frame
- Product no. A37386



- **Efficient grinder for asphalt road and pavement repairs and utility jobs**
- **Different type of teeth available**
- **Hydraulic side shift adapter and water spraying system for dust binding available as an option**

Working width	300 mm
Total width	660 mm
Grinding depth	0-80 mm
No. of cutting teeth	29 pcs
Height	480 mm
Length	810 mm
Weight	245 kg
Product no	A432621

220	225	225LPG	313S	320S	320S+	420	423	520	523	525LPG	528	530	R20	R28	R35	630	635	640	735	745	750	755i	760i	860i	e5	e6	



Very compatible



Compatible



Incompatible



# Concrete mixing bucket

Concrete mixing bucket is a handy tool when you need to make concrete without electricity or when you need to transport or lift the concrete to a place hard to access. The new model is equipped with a 400 mm screw shaft and a guard grill on the bucket. Two versions available: the bucket is emptied from the bottom hatch in the middle of the bucket, or on the left of the bucket. Hatch opening is powered by a hydraulic cylinder controlled with an electric directional valve, operation from driver's seat with an electric switch. The bucket is also equipped with a flexible 1350 mm emptying tube which mounts on the bottom hatch. This enables pouring of the concrete further away from the bucket.

- **Easy and efficient way to make concrete in places where electricity is not available**
- **The mixed concrete is easy and effortless to transport and pour into desired place**
- **Self loading - sand can be taken to the bucket directly from the pile**
- **Concrete can be poured to over 2 m height**



Total width	1490 mm
Screw shaft diameter	400 mm
Volume	210 l
Empty weight	299 kg
Weight at max. capacity	794 kg
Unloading hatch diameter	180 mm
Emptying tube length	1350 mm
Product no., emptying in the middle	A36473
Product no., emptying on the left	A37241

220	225	225LPG	313S	320S	320S+	420	423	520	523	525LPG	528	530	R20	R28	R35	630	635	640	735	745	750	755i	760i	860i	e5	e6	



## Drum type concrete mixer

Concrete mixing drum is a handy tool when you need to make concrete without electricity or when you need to transport or lift the concrete to a place that is hard to reach. Mixing is done hydraulically and emptying is done simply by tipping the drum forward.

- **Economical attachment for more occasional concrete mixing**
- **Easy way to make concrete in places where electricity is not available**
- **Ready mixed concrete is easy to transport and lift to desired place**



Volume	100/170 l (concrete/water)
Operation	hydraulic
Weight	65 kg
Product no	A36951

220	225	225LPG	313S	320S	320S+	420	423	520	523	525LPG	528	530	R20	R28	R35	630	635	640	735	745	750	755i	760i	860i	e5	e6	



Very compatible



Compatible



Incompatible



# Vibrating plate

Vibrating plate is destined for earth compacting and is easy to attach to an Avant. Compacting is easy and safe with the vibrating plate connected to Avant's quick attach plate – the operator is not exposed to vibrations or excessive noise.

- **Efficient compacting also in places where bigger compactors don't fit**
- **Fast and easy mounting on Avant**



Weight	150 kg
Plate size	285 x 500 mm
Impact force	900 kg
Impact rate	2000 bpm
Product no	A21012

220	225	225LPG	313S	320S	320S+	420	423	520	523	525LPG	528	530	R20	R28	R35	630	635	640	735	745	750	755i	760i	860i	e5	e6	



Very compatible



Compatible



Incompatible





## Disc scraper

Disc scraper is an excellent and cost efficient tool for removing of carpet and floor tiles in demolition and refurbishing jobs. The durable disc takes off old carpet and tiles quickly and efficiently.

- **Efficient and economical carpet remover**
- **Fits on all Avants**
- **Equipped with two Avant 29 kg counterweights A35957**



Disc diameter	560 mm
Length	960 mm
Width	560 mm
Height	507 mm
Weight	83 kg
Product no	A36910

220	225	225LPG	313S	320S	320S+	420	423	520	523	525LPG	528	530	R20	R28	R35	630	635	640	735	745	750	755i	760i	860i	e5	e6



Very compatible



Compatible



Incompatible

# Submersible pump

Digging and construction

Submersible pump is a very useful attachment for situations where larger amounts of water or other fluids need to be drained from trenches, pits, wells etc. Pumping capacity is as high as 2000 l/min and fluid can be taken up from max. 20 m depth. The pump is equipped with a 16,5 m long discharge hose. The 10 m long hydraulic hose kit is the same as for handheld tools.



- **Efficient pump for draining of water or other fluids from trenches, pits, wells etc.**
- **Fluid can be taken up from max. 20 m depth**
- **Equipped with 16,5 m long discharge hose**

Pumping capacity max.	2000 l/min
Pumping depth max.	20 m
Aux. hydr. oil flow max.	40 l/min
Width	350 mm
Height	700 mm
Weight	20 kg
Product no.	A36708

Option:  
Hydraulic hose kit, 10 m, with multi connector A36707

220	225	225LPG	313S	320S	320S+	420	423	520	523	525LPG	528	530	R20	R28	R35	630	635	640	735	745	750	755i	760i	860i	e5	e6	

Very compatible      Compatible      Incompatible

# All-round grapple

Farming and horse stables

This versatile tool can be used for lifting and transporting of many different types of materials which cannot be handled with a normal bucket or pallet fork. The grapple is equipped with a hydraulic cylinder in the upper grapple part and it opens all the way up in vertical position. This, together with the pressing force of the cylinder, gives excellent loading and handling capabilities. Total width is 900 mm - this allows traveling through narrow doorways and working in small spaces.



- **Simple and robust hydraulic grapple for handling of various materials**

Width	Weight	Product no
900 mm	65 kg	All 10

220	225	225LPG	313S	320S	320S+	420	423	520	523	525LPG	528	530	R20	R28	R35	630	635	640	735	745	750	755i	760i	860i	e5	e6	

Very compatible      Compatible      Incompatible



# Silage fork

A robust silage fork equipped with a powerful hydraulic cylinder, can be fitted on all Avant loader models. The strong blade type pins of the grapple penetrate into all types of feed. The fork has replaceable lower tines made of reinforced steel. The grapple goes up to vertical position and this, together with the powerful cylinder enables easy grabbing e.g. on a round bale.

- Compact model, which is well suited for silage distributing in small and confined places.
- The front edges on the forks are rounded, which offers a smaller turning diameter
- Mounting plate which increases tipping angle by 17 degrees is available as an option



Option:  
Mounting plate which increases tipping angle by 17 degrees A36337  
(only for special applications, risk of puncturing the front tyres)

Width	Weight	Product no
800 mm	120 kg	A428328
900 mm	126 kg	A36299
1050 mm	138 kg	A36313
1300 mm	160 kg	A36319

220	225	225LPG	313S	320S	320S+	420	423	520	523	525LPG	528	530	R20	R28	R35	630	635	640	735	745	750	755i	760i	860i	e5	e6

Very compatible
  Compatible
  Incompatible



# XL Silage grab

The larger silage grab series is intended for Avant 500, 600, 700 and 800 series loaders, with three different widths to match machines perfectly. The new series can carry up to 30 % more silage without losing visibility on the feeding table. Open grab construction on the top offers better visibility when the grab is open. Strong heavy duty construction with two cylinders. Forged bolt-on tines also on the top grab.

- **Larger silage grab model, designed for larger cow houses and bigger estates**
- **The top grab construction is completely open from the middle → Improved visibility when driving while the grab is open.**
- **Top grab has two cylinders for improved compression power**



Width	Weight	Product no
1300 mm	230 kg	A441007
1450 mm	245 kg	A440998
1600 mm	260 kg	A440586

Optional extras:  
Mounting bracket which increases tipping angle by 17 degrees A34587

220	225	225LPG	313S	320S	320S+	420	423	520	523	525LPG	528	530	R20	R28	R35	630	635	640	735	745	750	755i	760i	860i	e5	e6	



# Silage dozer blade

Intended for moving uneaten silage back to the cattle on the feeding table. Mounts on the normal or XL silage grab simply by closing the upper grapple on the dozer blade. The blade can be grabbed with the silage grab from two sides which means that it can move the silage both to the right or to the left. Equipped with a durable nylon blade.

- **Easy and economical way to push uneaten silage back to the cattle on the feeding table**
- **Mounts on normal and XL silage grabs**
- **Can be grabbed from two sides – moves silage to the right or to the left**



Blade length	1800 mm
Working width	1100 mm
Weight	92 kg
Product no	A37111

220	225	225LPG	313S	320S	320S+	420	423	520	523	525LPG	528	530	R20	R28	R35	630	635	640	735	745	750	755i	760i	860i	e5	e6



Very compatible



Compatible



Incompatible



# Feeding table cleaning blade

This cleaning blade is specially designed for clearing the cattle feeding table before distributing new silage to the table. The cleaning blade can be mounted by driving the silage fork into the blade, no need to get out of the driver's seat which speeds up the cleaning process, because no attachment change is necessary. The cleaning blade has a rubber lip on the lower surface that ensures good cleaning result.

**ATTENTION!** Available only together with Avant silage forks.

- The easiest way to clean the cattle feeding table
- Mounts on Avant silage forks: drive the fork into the blade with the grapple open and press the grapple down to lock the blade → no need to get out of the driver's seat.



## For silage fork

Width	1200 mm
Side extension width	550 mm
Weight	50 kg
Product no	A2936

## For XL silage grab

Width	1650 mm
Side extension width	550 mm
Weight	75 kg
Product no	A35512

Optional extras:

Extra side extension A46337

220	225	225LPG	313S	320S	320S+	420	423	520	523	525LPG	528	530	R20	R28	R35	630	635	640	735	745	750	755i	760i	860i	e5	e6	





# Silage dispenser

The robust dispenser bucket is equipped with hydraulically driven elevator in the bottom and discharging to both right and left side. Especially recommended for precision chopped silage and feeding stuffs made with feeder mixers. Adjustable side hatches allow controlled distribution of looser materials like crushed grain as well. The dispenser bucket is equipped with straight edge can be filled like a normal bucket directly from floor level. Distributes silage to about 10 cows / fill - it takes approx. 10 minutes to distribute silage to 50 cows. Manual side hatch adjustment is standard feature, hydraulic side hatch operation is available as an option.

- **Quick and easy way to distribute silage**
- **Silage can be distributed to the left or the right side**
- **Can be tilted down to ground level and filled like a normal bucket**
- **Manual side hatch adjustment as standard, hydraulic side hatch operation available as an option**



Option:  
Hydraulic side hatch operation A429734

Volume	650 l
Bucket width	1100 mm
Total width	1360 mm
Height	1200 mm
Weight	328 kg
Product no	A424013

220	225	225LPG	313S	320S	320S+	420	423	520	523	525LPG	528	530	R20	R28	R35	630	635	640	735	745	750	755i	760i	860i	e5	e6	



Very compatible



Compatible



Incompatible



## Feed mover screw

Efficient way of moving uneaten feed back in front of the cattle. When moving, the screw mixes the feed and the fresh feed remains on top.

With the feed mover screw drive speed can be higher, over 10 km/h. Feed can be moved both to the right and to the left simply by changing the rotation direction. The plastic scraper blade at the rear of the attachment cleans the feeding table very efficiently.

- **Fast and easy way of moving feed to the animals**
- **Discharge in both directions**
- **High efficiency, also on larger farms**
- **Scraper blade cleans the feeding table efficiently**



Working width	1400 mm
Total width	1635 mm
Weight	120 kg
Product no	A21506

220	225	225LPG	313S	320S	320S+	420	423	520	523	525LPG	528	530	R20	R28	R35	630	635	640	735	745	750	755i	760i	860i	e5	e6	





# Silage block cutter

Powerful and robust silage cutters with two hydraulic cylinders. With the silage cutter you can easily cut silage directly from the silo and take it to the cattle. Cutting blades are made of special steel; they cut very efficiently and leave a clean and even surface in the silo. This prevents air getting into silage and warming up. Thanks to the open design of the cutting blade visibility during silage distribution is very good. Lower tines are made of hardened steel.

- **Strong and robust design, cuts efficiently also tightly packed silage.**
- **1000 mm cutter takes silage for 8 cows, 1300 mm cutter for 12 cows at a time.**
- **Open design – good visibility also when distributing the silage**
- **Strong lightweight construction**
- **Tines made of hardened steel**



Width	1000 mm	1300 mm
Weight	245 kg	280 kg
Product no	A21276	A21257

220	225	225LPG	313S	320S	320S+	420	423	520	523	525LPG	528	530	R20	R28	R35	630	635	640	735	745	750	755i	760i	860i	e5	e6	



Very compatible



Compatible



Incompatible



# Carousel broom

The hydraulically operated carousel broom is a useful attachment when sweeping materials to the side or away from the wall. Rotates in both directions, can be turned manually to both sides by max. 57 degrees (1090 mm), which allows sweeping next to the wall also. Carousel broom can be used for various sweeping tasks especially in farm environment.

- **Strong broom, moves materials efficiently**
- **Side shift allows brushing next to the wall also**
- **Rotates in both directions**
- **Can be turned manually to both sides, in different positions, by max. 57 degrees (1090 mm) – allows sweeping next to the wall also**
- **Equipped with replaceable 1000 mm diameter nylon brush**

Width	1000 mm
Broom diameter	1000 mm
Turning angle max.	+/- 57 °
Broom material	Nylon
Weight	70 kg
Product no	A2971



220	225	225LPG	313S	320S	320S+	420	423	520	523	525LPG	528	530	R20	R28	R35	630	635	640	735	745	750	755i	760i	860i	e5	e6	



Very compatible



Compatible



Incompatible



# Round bale grab

With the round bale grab you can lift and transport wrapped silage bales, hay bales and other round bales without damaging the plastic wrapping or net. Sturdy, yet light construction allows best possible effective load (see the table below).

- **The round bale grab transports all wrapped bales without damaging the wrappings**
- **With Avant and bale grab you are able to pile three round bales on top of each other**



Weight	120 kg
Max. bale weight	
Avant 400 series	400 kg
Avant 520/523	550 - 650 kg
Avant 528/530	850 - 950 kg
Avant 600 series	950 - 1050 kg
Avant 700 series	1100 - 1200 kg
Avant 800 series	1100 - 1200 kg
Max. grab width	1500 mm
Bale diameter	950 - 1450 mm
Product no	A21166

220	225	225LPG	313S	320S	320S+	420	423	520	523	525LPG	528	530	R20	R28	R35	630	635	640	735	745	750	755i	760i	860i	e5	e6	



Very compatible



Compatible



Incompatible



# Bale handler

Bale handler is an economical way to handle wrapped bales, without damaging the plastic wrapping. Distance between the forks can be adjusted manually. Bale handler is a good choice if the bales can always be handled sideways and don't need to be grabbed. This also means that the bale handler isn't as versatile as a bale grab.

- **Economical way to handle wrapped bales**
- **Adjustable fork width**
- **Useful attachment for situations where bales don't need to be grabbed**
- **Equipped with load support frame**



Width min.	1035 mm
Weight	83 kg
Product no	A36262

220	225	225LPG	313S	320S	320S+	420	423	520	523	525LPG	528	530	R20	R28	R35	630	635	640	735	745	750	755i	760i	860i	e5	e6	



# Bale fork

With the round bale fork transporting and lifting of bales is easy and safe. Square bale fork makes it easy and safe to transport and lift unwrapped square bales.

Strong and simple construction ensures a long lifespan.

- **Easy and economical way to lift and transport bales**
- **Two models: for round and square bales**

Model	Square bale fork	Round bale fork
Width	1005 mm	1220 mm
Length	1145 mm	1150 mm
Weight	58 kg	55 kg
Tines	3 pcs	2 pcs
Prod. no	A410225	A410224



220	225	225LPG	313S	320S	320S+	420	423	520	523	525LPG	528	530	R20	R28	R35	630	635	640	735	745	750	755i	760i	860i	e5	e6	



Very compatible



Compatible



Incompatible



# Round bale splitter

Avant round bale splitter splits also frozen bales which are otherwise hard to handle. Splitting is fast and efficient thanks to the form of the cutting blade and the strong hydraulic cylinder. The bale can also be transported with the splitter. Wide and open design allows splitting of various size bales.

- **Efficient round bale splitter, splits also frozen bales**
- **Bales can also be transported with the splitter, without splitting**
- **Wide and open design allows splitting of various size bales**



Splitting force	2,2 t
Tines	2 pcs long, 2 pcs short
Cutting blade length	1987 mm
Total length	2050 mm
Width	1250 mm
Height with blade up	2200 mm
Height with blade down	980 mm
Weight	305 kg
Product no	A36199

220	225	225LPG	313S	320S	320S+	420	423	520	523	525LPG	528	530	R20	R28	R35	630	635	640	735	745	750	755i	760i	860i	e5	e6	



# Bedding distributor bucket

The bedding distributor bucket is intended for distribution of different types of beddings in cowhouses, poultry farms etc. The bucket is equipped with a 300 mm wide belt, which allows distribution of chopped straw, sawdust, peat, bark, wood shavings, sand and lime. Belt speed is steplessly adjustable.

The bucket is equipped with a mixing shaft which distributes the material evenly on the belt. Discharge to the left or to the right. Rubber scraper blade, destined for cleaning the floor grates, is available as an option. It mounts under the bucket.

- **Efficient distribution of various types of beddings in cowhouses, poultry farms etc.**
- **Equipped with 300 mm wide belt - belt speed steplessly adjustable by adjusting engine revs**
- **Discharge to the left or to the right**
- **Rubber scraper blade for floor cleaning available as an option**

Volume	800 l
Belt width	300 mm
Belt speed	0-10 m/s, steplessly adjustable
Width	1400 mm
Weight	340 kg
Product no	A36532

Option: Rubber scraper blade A37162



220	225	225LPG	313S	320S	320S+	420	423	520	523	525LPG	528	530	R20	R28	R35	630	635	640	735	745	750	755i	760i	860i	e5	e6	



Very compatible



Compatible



Incompatible

# Manure fork

Avant manure fork is a very useful attachment, destined for detaching and handling of manure and similar materials. The strong tines, made of high tensile forged steel, penetrate also into compacted manure and can carry a heavy load.

- Strong fork for handling of manure and similar materials
- Equipped with bolt-on replaceable tines, made of high tensile forged steel



Width	1100 mm
Tine length	1000 mm
Fork length	1110 mm
Height	415 mm
Weight	60 kg
Product no	A36038

220	225	225LPG	313S	320S	320S+	420	423	520	523	525LPG	528	530	R20	R28	R35	630	635	640	735	745	750	755i	760i	860i	e5	e6	

Very compatible      Compatible      Incompatible

# Grain/flour dispenser bucket

Avant grain dispenser is a 300 l bucket equipped with a hydraulic motor and a Ø 200 mm screw, destined for distribution of flour, crushed grain etc. The bucket is available in two versions: with discharge either to the right side or to the left side.

The edge of the grain dispenser tilts all the way down so that loading from ground level is easy.

- Easy distribution of flour, crushed grain etc.
- Self-loading when needed: loading from ground level like with a normal bucket is also possible
- Two versions available: discharge to the right or to the left



Volume	300 l
Width	1100 mm
Weight	90 kg
Product no., discharge to the right	A1194
Product no., discharge to the left	A36559

220	225	225LPG	313S	320S	320S+	420	423	520	523	525LPG	528	530	R20	R28	R35	630	635	640	735	745	750	755i	760i	860i	e5	e6	

Very compatible      Compatible      Incompatible



**New**

**Farming and horse stables**



# Grain/flour dispenser bucket XL

The large volume 500 l grain dispenser bucket is destined especially for bigger Avant loaders. It is an ideal attachment for distribution of flour, grain, crushed grain, different types of feed in granule form etc. Thanks to the strong Ø210 mm hydraulic discharge screw which can be rotated in both directions the material can be distributed to the right or to the left side. The adjustable side hatches with proper sealing guarantee that the material doesn't fall out unintentionally. The bucket can be tilted all the way down so that loading from ground level is easy.

Two models available: with manual side hatch adjustment or with hydraulic side hatch adjustment.



- **Quick and easy way to distribute grain, crushed grain, flour etc. feed in granule form**
- **Material can be distributed to the left or the right side**
- **Can be tilted down to ground level and filled like a normal bucket**
- **Available with either manual or with hydraulic side hatch adjustment**

Volume	500 l
Bucket width	1300 mm
Total width with rubber guide flaps	1650 mm
Height	960 mm
Length	940 mm
Weight	250 kg
Product no. manual side hatches	A435290
Product no. hydraulic side hatches	A439905

220	225	225LPG	313S	320S	320S+	420	423	520	523	525LPG	528	530	R20	R28	R35	630	635	640	735	745	750	755i	760i	860i	e5	e6	

Very compatible
  Compatible
  Incompatible



# Push broom

Push broom is a handy and inexpensive broom for cleaning of smaller areas. Push broom has no rotating parts - it simply pushes the material in front of the broom.

Push broom can also be used when making pavements. By pushing the filler sand sideways across the paving stones the sand will fall nicely between the stones.

- **An inexpensive and simple broom**
- **No rotating parts → less dust when brushing**
- **Fits perfectly for horse stables, farming, other small scale brushing.**



Width	1300 mm	2000 mm
Weight	34 kg	67 kg
Product no	A34055	A36453

220	225	225LPG	313S	320S	320S+	420	423	520	523	525LPG	528	530	R20	R28	R35	630	635	640	735	745	750	755i	760i	860i	e5	e6	



# 3 point hitch adapter

With the 3 point hitch adapter it is possible to move agricultural attachments with Avant, for instance for storage, cleaning etc. This can be practical especially when space is limited and handling with tractor is difficult. Also the trailer ball hitches can be mounted on the 3 point hitch adapter.

**Notice:** Please also read the disclaimer on page 167 about mounting the adapter on Avant loaders

- **Easy way to handle agricultural attachments with Avant**
- **Equipped with CAT2 tractor hitch as standard - CAT1 mounting kit is available as an option**
- **Avant trailer ball hitches can also be mounted, as an option**



Option:  
 CAT1 mounting kit A418980  
 Trailer ball hitch 50 mm A417323  
 Trailer ball hitch 50 mm with towing pin A417337

Type	CAT 2
Weight	57 kg
Product no	A36433

220	225	225LPG	313S	320S	320S+	420	423	520	523	525LPG	528	530	R20	R28	R35	630	635	640	735	745	750	755i	760i	860i	e5	e6	

Very compatible
  Compatible
  Incompatible



# Slurry mixer

Slurry mixer is a special attachment for cattle farms: in cattle buildings with slatted floors, where the animal waste falls through the slats directly to the storage tank below the floor. The slurry that forms in the tank needs to be mixed from time to time in order that it stays liquid and moves towards the bigger slurry container which is usually located outside the building.

The unit is equipped with a propeller which mixes the slurry, powered by a hydraulic motor. The mixer is 25 mm thick and 490 mm wide so that it fits through/between the floor slats into the storage tank. Working depth is max. 1,5 m. There is also a bolt at the upper end of the mixing shaft which shows when the mixer can be lifted up through the slat: when the bolt is crosswise in relation to the loader. The mixer is also equipped with a coupling for water hose at the upper end of the frame tube. Water is conducted inside the tube down to the mixing propeller.



- **Special attachment for mixing of slurry in cattle buildings with slatted floors**
- **Equipped with a propeller, powered by a hydraulic motor, which mixes the slurry**
- **Fits through/between the floor slats into the storage tank below – no need to remove the heavy concrete slats**
- **Galvanized steel frame, mixing shaft and propeller made of acid-resisting steel**
- **Coupling for water hose on the frame tube**

Frame thickness x width	25 mm x 490 mm
Working depth max.	1500 mm
Total width	550 mm
Length	920 mm
Height	2155 mm
Weight	75 kg
Product no	A37389

220	225	225LPG	313S	320S	320S+	420	423	520	523	525LPG	528	530	R20	R28	R35	630	635	640	735	745	750	755i	760i	860i	e5	e6	



# Horse manure collector

Horse manure collector is a simple and economical way to collect horse manure. It works well on many surfaces (saw dust, horse arenas). Mounts directly on any Avant bucket.

- **Simple and economical way to collect horse manure**
- **Mounts on Avant general and light material buckets**

Width	950 mm
Weight	29 kg
Product no	A36292

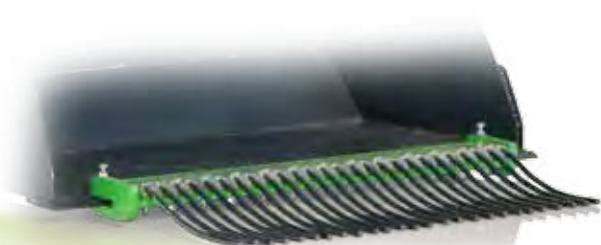

220	225	225LPG	313S	320S	320S+	420	423	520	523	525LPG	528	530	R20	R28	R35	630	635	640	735	745	750	755i	760i	860i	e5	e6



Very compatible



Compatible



Incompatible



# Front cultivator

Front cultivator can be used for instance together with the horse arena harrow. Especially useful in a more compacted arena or an outdoor riding area. It is equipped with large tines which loosen the soil and make harrowing of the arena easier. Equipped with two wheels in the front.

- **Efficient and easy way to loosen compacted soil**
- **Equipped with replaceable tines**
- **Can be mounted on all Avants**



Width	1410 mm
Length	725 mm
Height	630 mm
Number of tines	7 pcs
Working depth	0 - 150 mm
Weight	80 kg
Product no	A36555

220	225	225LPG	313S	320S	320S+	420	423	520	523	525LPG	528	530	R20	R28	R35	630	635	640	735	745	750	755i	760i	860i	e5	e6



# Horse arena harrow

The horse arena harrow is intended for levelling and loosening of horse arena riding surfaces. The harrow has two spring loaded tine rows which loosen the surface, a leveller that makes the surface completely even and a tilling roller that compacts the ground and leaves a finished surface perfectly suited for horse's hoof. The harrow doesn't damage the lower levels (understructure) of the riding surface.

The horse arena harrow features:

- A clearing shovel which takes away and levels the sand from the sides of the riding arena.
- A tilling roller that smoothens the harrowed ground and leaves a finished surface.
- A large wheel that protects the walls of the riding arena in case the harrow hits the wall.



Options:

- Manually operated support wheels, product no. A36593
- Hydraulically operated support wheels, product no. A37547. The loader must be equipped with the optional double acting rear auxiliary hydraulics outlet.
- Weights with handle, 29 kg, which can be mounted on the harrow to increase weight and make harrowing more efficient. With two weights the harrow works on almost any surface. The weight is the same extra weight as on Avant loader, product no. A35957.
- Water spraying system, product no. A37065

- **A professional harrow that makes it easy to keep the horse arena in top condition**
- **Can be adjusted for several kinds of riding surfaces**
- **Once the adjustments have been done the harrow is very easy to use**
- **Two types of support wheels – manually or hydraulically operated - available as an option: the harrow can be lifted off the ground and towed to desired place**
- **Water spraying system available as an option, with 120 l water tank**



Working width	1530 mm
Weight (without 29 kg extra weights)	165 kg
Product no	A21646

220	225	225LPG	313S	320S	320S+	420	423	520	523	525LPG	528	530	R20	R28	R35	630	635	640	735	745	750	755i	760i	860i	e5	e6	



Very compatible



Compatible



Incompatible



# Big bag transporter

With the big bag transporter you can lift and transport big bags safely and securely. This simple attachment makes loading of fertilizer or stacking big bags as easy as it can get.

- An inexpensive and safe way to handle big bags
- Lift hook can be adjusted in four different heights between 1200 - 1800 mm



Lift hook height	1200/1400/1600/1800 mm
Width	1000 mm
Weight	80 kg
Product no	A36221

220	225	225LPG	313S	320S	320S+	420	423	520	523	525LPG	528	530	R20	R28	R35	630	635	640	735	745	750	755i	760i	860i	e5	e6	

Very compatible
  Compatible
  Incompatible





# Stone collecting bucket

The stone collecting bucket - also known as riddle bucket - is intended mainly for collecting stones from the fields after the field has been harrowed. With an Avant 400, 500, 600, 700 or 800 series it is easy and fast to collect stones from nearby fields.

- **Easy and fast way to collect stones from fields**
- **Equipped with strong and durable bars**

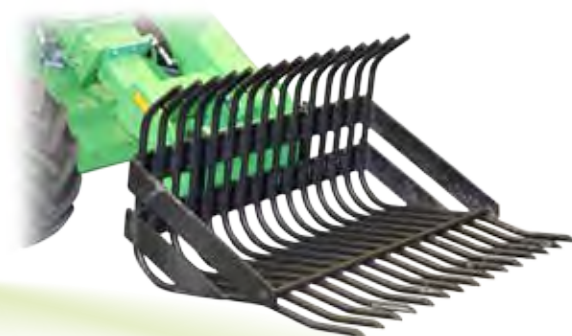

Width	1050 mm	1370 mm
Bar diameter	22 mm	30 mm
Weight	95 kg	250 kg
Product no	A2999	A415432

Modell	220	225	225LPG	313S	320S	320S+	420	423	520	523	525LPG	528	530	R20	R28	R35	630	635	640	735	745	750	755i	760i	860i	e5	e6
1050	Compatible	Compatible	Compatible	Compatible	Compatible	Compatible	Compatible	Compatible	Compatible	Compatible	Compatible	Compatible	Compatible	Compatible	Compatible	Compatible	Compatible	Compatible	Compatible	Compatible	Compatible	Compatible	Compatible	Compatible	Compatible	Compatible	Compatible
1370	Compatible	Compatible	Compatible	Compatible	Compatible	Compatible	Compatible	Compatible	Compatible	Compatible	Compatible	Compatible	Compatible	Compatible	Compatible	Compatible	Compatible	Compatible	Compatible	Compatible	Compatible	Compatible	Compatible	Compatible	Compatible	Compatible	Compatible



Very compatible



Compatible



Incompatible

# Generator

Make electricity with Avant! – The generator is equipped with 1x400V and 2x230V outlets. Generator can be used as a power source for power tools and small electrical appliances in places where net current is not available. High quality generator also guarantee electric current supply during power outages.

- **Make electricity with Avant in places where mains current is not available**
- **For power tools, small electric appliances and electricity during shorter power outages**

Power Packs



Power	Outlets	Product no
6,5 kVA	2x230V & 1x400V	A35408

220	225	225LPG	313S	320S	320S+	420	423	520	523	525LPG	528	530	R20	R28	R35	630	635	640	735	745	750	755i	760i	860i	e5	e6	

Very compatible
  Compatible
  Incompatible

# Compressor

Makes it possible to have compressed air anywhere you go. Creates max. 400 l/min air flow @ 8 bar pressure. Can be used for running power tools and, for example, filling of large tyres in places where electric current is not available, and for cleaning of big machines like combined harvesters etc.

- **Easy way to get compressed air e.g. for pneumatic power tools**
- **Makes it possible to fill large tyres (agricultural & construction machines for example) in places where electric current is not available**
- **Fast cleaning of big machines with compressed air: combined harvester, construction machinery etc.**



Product no
A35409

220	225	225LPG	313S	320S	320S+	420	423	520	523	525LPG	528	530	R20	R28	R35	630	635	640	735	745	750	755i	760i	860i	e5	e6

Very compatible
  Compatible
  Incompatible



# Pressure washer

Powerful pressure washer with 20 m hose reel and a washing gun; easy to take anywhere with the Avant. Creates max. 30 l/min water flow @ 200 bar pressure. Can be connected directly to tap water supply, or water can be taken with the inlet hose from any reservoir. Can suck water via inlet hose from as much as 3 m below the level where the unit is. This is a very useful feature when taking water from a tank, reservoir, lake etc.

- **Powerful washer with high max. water flow and pressure**
- **Can be connected directly to tap, or with the inlet hose take water from as much as 3 m below ground level**
- **Equipped with 20 m hose reel and washing gun**



Max. water flow	Product no
30 l/min @ 200 bar	A35411

220	225	225LPG	313S	320S	320S+	420	423	520	523	525LPG	528	530	R20	R28	R35	630	635	640	735	745	750	755i	760i	860i	e5	e6	



# Winch

The Avant hydraulic winch enables towing of all kinds of objects (e.g. logs, poles, boats) from places where you cannot drive with the machine.

The winch is equipped with a safety net, 30 m of wire rope and a towing hitch. It is powered by a powerful hydraulic motor and mounts on Avant's quick attach plate. Use of the winch is simple, one person can easily handle it. Auxiliary hydraulics control lever is switched to continuous flow (locking position) from the driver's seat, which releases the wire drum so that the wire can be pulled out by hand. When the wire is attached to the desired object, operator returns to driver's seat and turns the auxiliary hydraulics lever to opposite direction and the winch begins to reel in the rope. The winch stops as soon as the auxiliary hydraulics control lever is released.

- **Powerful and compact hydraulic winch for various tasks**
- **The winch is mounted directly on Avant's quick attach plate, so you are also able to use the boom for lifting materials with the winch.**
- **Equipped with wire rope guiding rollers**



Max. Pulling power	1000 kp
Max. Reeling speed	0,5 m/s @ 20 l/min (recommended oil flow)
Wire length	30 m
Weight	105 kg
Product no	A36960

220	225	225LPG	313S	320S	320S+	420	423	520	523	525LPG	528	530	R20	R28	R35	630	635	640	735	745	750	755i	760i	860i	e5	e6	





# Tree shear

Avant tree shear is an efficient and useful tree cutter, intended for forest thinning, tree clearance and similar jobs where smaller trees need to be cut. The strong grapple takes a firm grip of the tree trunk and a hydraulic cylinder pushes the cutting blade against the trunk and cuts it. The tree is then easy and fast to move away with Avant. If needed, the cutting blade can be turned 180 degrees to point backwards. This means it doesn't cut and the unit can be used as a grapple only.

- **Powerful tree cutter for max. 190 mm diameter trees**
- **Excellent tool for forest thinning, tree clearance etc.**
- **Thanks to the strong grapple the tree is easy to take away with Avant**
- **Can also be used as a grapple only, by turning the cutting blade to point backwards**

Tree diameter	max. 190 mm
Grapple opening	770 mm
Weight	110 kg
Product no	A35831



220	225	225LPG	313S	320S	320S+	420	423	520	523	525LPG	528	530	R20	R28	R35	630	635	640	735	745	750	755i	760i	860i	e5	e6	



Very compatible



Compatible



Incompatible



## Log grab, heavy duty

A strong log grab for customers who need to move tree trunks, logs etc. often. The grab takes a firm grip on the wood and the lower tines are also better formed for grabbing bigger tree trunks.

- **Strong log grab, also for more professional and frequent log handling**
- **Heavy duty design allows grabbing of bigger tree trunks as well**
- **Grabbing and transporting of bigger stones and similar objects also possible**



Width	845 mm
Height	990 mm
Weight	180 kg
Product no	A415691

220	225	225LPG	313S	320S	320S+	420	423	520	523	525LPG	528	530	R20	R28	R35	630	635	640	735	745	750	755i	760i	860i	e5	e6	





## Log grab

The Avant log grab mounts on Avant pallet fork. With the log grab you can lift and transport single logs or smaller timber bundles. The grab is equipped with a powerful hydraulic cylinder and can therefore also lift bigger stones, as well as branches, fence poles and similar objects.

Requires also:

Pallet fork 850 mm (A21047) or

Pallet fork 1100 mm (A21039) or

Pallet fork 1200 mm (A36589)

- **Easy mounting on pallet fork**
- **Basic attachment for fencing and forest work**
- **Grabbing and transporting of stones and similar objects also possible**



Max. diameter to grab	Min. diameter to grab	Weight	Product no
900 mm	Ø 180 mm	50 kg	A33503

Assembled to pallet forks

220	225	225LPG	313S	320S	320S+	420	423	520	523	525LPG	528	530	R20	R28	R35	630	635	640	735	745	750	755i	760i	860i	e5	e6	



Very compatible



Compatible



Incompatible



## Timber grab

Timber grab is an attachment that allows you to grab tree trunks, branches, wood waste, kerb stones etc. and transport them both lengthwise and crosswise. This makes it possible to pass through narrow places also with long logs and enables loading on trailer or on a pile in any direction. Timber grab is available either with a hydraulic rotator or as freely rotating version. If the loader is equipped with the 6 or 8 function joystick, all functions of the grab with hydraulic rotator (grab opening/closing, rotation) can be operated with the switches on the optional Opticontrol switch pack.



Option:  
Arborist kit (tree pusher) A427744  
Lock valve, mounting kit, on grab cylinder A436627

- **Versatile grab for transporting and loading of tree trunks, branches, kerb stones etc.**
- **Rotating grab allows transporting also lengthwise - makes it possible to pass through narrow places with long logs and facilitates work in dense forest**
- **Available with hydraulic rotator or as freely rotating version**

Rotation type	Freely rotating	Hydraulic rotation
Grapple opening diameter	1223 mm	1223 mm
Grip area	0,16 m <sup>2</sup>	0,16 m <sup>2</sup>
Weight	116 kg	136 kg
Product no	A37457	A37456

The optional Opticontrol is recommended with grab with hydraulic rotator, for operating the grab opening/closing and rotation (requires also 6 or 8 function joystick on the loader).

220	225	225LPG	313S	320S	320S+	420	423	520	523	525LPG	528	530	R20	R28	R35	630	635	640	735	745	750	755i	760i	860i	e5	e6	





**New**

**Forestry**



# Timber grab HD

The heavy duty timber grab is equipped with a stronger boom and hydraulic rotator and larger grapple. It is intended especially for Avant 700 and 800 series. The arborist kit which mounts on the boom is also standard feature. When cutting a tree you can push the tree down with it if necessary, instead of pushing by hand. It is also possible to attach a rope on the bracket on the kit, which enables towing the logs by pulling them with the loader.

- HD grab with stronger boom and rotator and larger grapple
- Arborist kit as standard
- Intended especially for 700 and 800 series

Rotation type	Hydraulic
Grapple opening diameter	1340 mm
Grip area	0,2 m <sup>2</sup>
Weight	280 kg
Product no	A438973

### Mounting on loader's quick attach plate

Rotation type	No rotation	Hydraulic
Grapple opening diameter	1340 mm	1340 mm
Grip area	0,2 m <sup>2</sup>	0,2 m <sup>2</sup>
Weight	160 kg	210 kg
Product no	A436473	A437203

The optional Opticontrol is recommended with grab with hydraulic rotator, for operating the grab opening/closing and rotation (requires also 6 or 8 function joystick on the loader).



There are also two timber grab models which mount directly on the attachment coupling plate of the loader: one with hydraulic rotator and one without rotator. They are equipped with the same grapple as the A438973 HD grab.

Model	220	225	225LPG	313S	320S	320S+	420	423	520	523	525LPG	528	530	R20	R28	R35	630	635	640	735	745	750	755i	760i	860i	e5	e6	
with boom	Red	Red	Red	Red	Red	Red	Red	Red	Red	Red	Red	Red	Red	Red	Red	Red	Red	Red	Red	Red	Red	Red	Red	Red	Red	Red	Red	Red
no boom	Red	Red	Red	Red	Red	Red	Red	Red	Red	Red	Red	Red	Red	Red	Red	Red	Red	Red	Red	Red	Red	Red	Red	Red	Red	Red	Red	Red

Very compatible
  Compatible
  Incompatible



## Log cutter/splitter

Avant log cutter/splitter is a very efficient firewood making machine. It combines a chain saw and a hydraulic log splitter. The hydraulically driven chain saw cuts the log, after cutting the log drops automatically on the splitting table where a hydraulic cylinder pushes the log against the splitting blade. Position of the splitting blade can be adjusted, according to the log diameter. The new model is equipped with a separate system with own oil tank for lubricating the saw chain. Discharge conveyor is available as an option. Discharge conveyor is available as an option (for 400-800 series).



- **Powerful and safe log processor**
- **Automated functions make work safe and efficient**
- **Discharge conveyor available as an option**

Max. log diameter	300 mm
Max. log length	450 mm
Saw flange	13"
Max. splitting force	5,6 tons
Conveyer belt length	2,3 m
Weight	310 kg
Weight, discharge conveyor	75 kg
Product no with collector bucket	A441909
Product no with conveyor	A441910

220	225	225LPG	313S	320S	320S+	420	423	520	523	525LPG	528	530	R20	R28	R35	630	635	640	735	745	750	755i	760i	860i	e5	e6





# Wood chipper CHI100

Wood chipper CHI100 is a compact and robust disc chipper which works also on Avant 200 series 2 and 400 series. With it you can chip branches and small trees up to 100 mm diameter - an ideal tool for chipping wood in smaller scale. Two knives and an anvil take care of chipping and feeding. Wood feeding is manual.

- **Robust and compact disc chipper, works on 200 series 2 and 400 series as well**
- **Excellent tool for chipping branches and small tree trunks**
- **Manual feeding and discharge chute rotation (can be turned to discharge to the right or to the left)**
- **Equipped with safety stop system**



Max wood diameter	100 mm
Chip length	appr. 12 mm
Chipping drum	Hydraulic motor with direct drive
Chute turn	180 degrees (can be mounted to eject to the right or to the left)
Weight	210 kg
Product no	A415436

220	225	225LPG	313S	320S	320S+	420	423	520	523	525LPG	528	530	R20	R28	R35	630	635	640	735	745	750	755i	760i	860i	e5	e6	



Very compatible



Compatible



Incompatible



# Wood chipper CHI 180

“The CHI180 wood chipper is an efficient and modern disc chipper, equipped with 4 blades and intended for Avant 600-800 series. It takes in dry twigs, branches and tree tops up to 180 mm diameter and makes 12 mm long chips. Material is loaded manually in the infeed chute, but the chipper is equipped with hydraulic feeding rollers and Smart Feed system which monitors rotating speed of the cutting disc. If e.g. too much wood is loaded in the infeed chute and the speed of the disc slows down considerably, the rollers reverse a bit which prevents blocking and stopping of the chipper. The adjustments of the Smart Feed system can also be programmed if necessary.

Discharge chute can be rotated manually 290°, and throwing height can also be adjusted by hand. Thanks to the modular design maintenance is easy, and with the discharge chute turned into transport position the CHI180 is a compact package.

CHI180 complies with the latest EN 13525 standard for wood chippers. It meets the criteria of the standard regarding the distance between the infeed chute and blades (min. 1500 mm), and infeed chute's bottom must be at least 600 mm above the ground. The Smart Feed rotation control system also includes an electric emergency stop switch.

- **Powerful wood chipper for professional use**
- **Smart Feed hydraulic feeding system and cutting disc speed monitoring (no-stress in-feed control) make chipping easier and more efficient**
- **Meets the requirements of latest safety standards for wood chippers, including electric emergency stop switch**

Chip length	12 mm
Max wood diameter	180 mm
Number of blades	4 pcs
Feeding system	hydraulic, Smart Feed
Discharge chute rotation	manual, 290°
Weight	380 kg
Product no	A441997

220	225	225LPG	313S	320S	320S+	420	423	520	523	525LPG	528	530	R20	R28	R35	630	635	640	735	745	750	755i	760i	860i	e5	e6
															*		*	*								



# Tilt adapter

Avant tilt adapter is mounted between the attachment and the loader's attachment coupling plate. With it the attachment can be tilted sideways, and makes it possible to:

- Make different forms to the ground with a bucket or leveller
- Keep pallet fork level when you are driving on surfaces with gradient
- Load pallets that are on uneven ground
- Level ground on uneven surfaces
- With the 90 degree tilt adapter rotate the attachment as much as 90°

There are two tilt adapters available:

- Tilt adapter with max. 12,5 degree tilting in both directions. It is intended for buckets, leveller and pallet fork – for jobs where tilting is a must but the tilting angle doesn't have to be big
- Tilt adapter with max. 90 degree rotation, or 45 degree tilting in both directions. It is useful in applications where the attachment needs to be rotated more in order to get the job done: with grabbing tool (rotating of barrels etc.), rock drill, artificial turf attachment (to fit through narrow doors) etc.

The hydraulic cylinder of the 90 degree tilt adapter can be mounted in two different positions, which gives two tilting angles: either 45° tilting in both directions, or 90° rotation in one direction. The tilt adapter is intended mainly for non-hydraulically operated attachments, but with the optional second auxiliary hydraulics outlet in the front it is possible to mount also hydraulically driven attachments like a 4 in 1 bucket, pallet fork with hydraulic fork adjustment, grabbing tool, artificial turf attachment and rock drill at the same time.

- **Makes it possible to tilt the attachment sideways and e.g. grade the ground with a bucket or leveller, or load pallets on uneven ground with pallet fork**
- **Mounts between the attachment and the quick attach plate of the loader**
- **Two models: with max. ± 12,5° tilting or with max. 90° / ± 45° rotation**

Options



Max. tilt	+/- 12,5 deg	90°, or ± 45°
Weight	65 kg	85 kg
Product no	A34148	A36505

220	225	225LPG	313S	320S	320S+	420	423	520	523	525LPG	528	530	R20	R28	R35	630	635	640	735	745	750	755i	760i	860i	e5	e6	

Very compatible
  Compatible
  Incompatible

# Attachment rotator

Attachment rotator makes it possible to rotate the attachment 360° continuously (endlessly) in both directions. This is useful in many jobs, for instance when emptying boxes which need to be turned upside down.



- **Hydraulic rotator makes it possible to empty boxes by turning them upside down, lifting of pallets on uneven ground, turning the attachment 360° etc.**
- **Mounts between the attachment and the quick attach plate of the loader**

Rotation	360° continuous
Rated max load	1200 kg
Weight	96 kg
Product no	A424406

220	225	225LPG	313S	320S	320S+	420	423	520	523	525LPG	528	530	R20	R28	R35	630	635	640	735	745	750	755i	760i	860i	e5	e6	

Very compatible
  Compatible
  Incompatible

# Hydraulic side shift adapter

The hydraulic side shift adapter offers easy, stepless side shift of attachment, operated from the driver's seat. The solid and robust design features strong sliding guides which can also be lubricated. The quick attach plate on the adapter can be mounted in three different positions: on the left or on the right or in the middle of the adapter. This gives three different side shift options: 500 mm side shift to the right or to the left, or 250 mm side shift in both directions.

If a hydraulic attachment – 4 in 1 bucket, flail mower, cold planer etc. – is mounted on the side shift adapter, the loader must be equipped with the optional second auxiliary hydraulics outlet in the front, so that the attachment hoses are mounted on the multi connector and the side shift adapter hoses on the optional second outlet.



- **Easy, stepless hydraulic side shift of the attachment, operated from the driver's seat**
- **Side shift max. 500 mm to the right or the left, or 250 mm in both directions, depending on the mounting of the adapter's attachment plate**
- **Max. load 1.000 kg**

Width	1270 mm
Height	434 mm
Length	218 mm
Weight	115 kg
Product no	A37235

220	225	225LPG	313S	320S	320S+	420	423	520	523	525LPG	528	530	R20	R28	R35	630	635	640	735	745	750	755i	760i	860i	e5	e6	

Very compatible
  Compatible
  Incompatible

# Side shift adapter

Side shift adapter is a rigid adapter plate which mounts on the loader's attachment coupling plate. It is equipped with two quick attach brackets, side by side, for mounting on the loader's attachment coupling plate. Quick attach pins for the attachment are on the opposite side of the adapter. This means that the attachment can be mounted on the adapter in two different positions:

- with side shift: the attachment is 600 mm to the side from the centerline of the loader's attachment coupling plate
- without side shift: the attachment is mounted on the brackets which are against the loader's attachment coupling plate



- **Moves attachment 600 mm to the side from centerline**
- **Two models available: 600 mm side shift to the right or to the left**

Side shift adapter	600 mm, right	600 mm, left
Width	1150 mm	1150 mm
Height	265 mm	265 mm
Length	157 mm	157 mm
Weight	45 kg	45 kg
Product no	A37097	A37166

220	225	225LPG	313S	320S	320S+	420	423	520	523	525LPG	528	530	R20	R28	R35	630	635	640	735	745	750	755i	760i	860i	e5	e6	

Very compatible
  Compatible
  Incompatible

# Adapter plate, weld-on

Avant offers a variety of original adapter plates, which can be welded directly onto:

- An attachment you have developed yourself.
- An object you wish to lift securely with Avant

All original Avant adapter plates will fit, which saves a lot of time consuming measuring and adjusting work from you.



Model	Product no
Quick attach brackets	A31566
Quick attach brackets HD	A37015
Adapter plate 10 mm	A2471
Adapter plate 20 mm	A2472

Options

220	225	225LPG	313S	320S	320S+	420	423	520	523	525LPG	528	530	R20	R28	R35	630	635	640	735	745	750	755i	760i	860i	e5	e6	

Very compatible
  Compatible
  Incompatible

## Disclaimer for Avant adapters

The following Avant adapters presented in this catalogue: 3 point hitch adapter A36433; Euro adapters A434684 and A434804; skid steer adapters A437407, A437144, A435531 and A442082 are suitable for use with Avant multi purpose loaders only. For compatibility with Avant loader model please contact your Avant dealer or consult the corresponding Operator's Manual of the attachment.

The adapter is mounted on the Avant loader like other attachments, between the attachment coupling plate of the loader and the attachment of the third party. The Avant adapters are suitable for temporary use, to lift or transport third party attachments occasionally, short distances. The Adapters are not designed for any other use than specified and must not be used for any other purposes than what they are intended for.

Avant Tecno Oy is not responsible for use or misuse of any third party attachments that are used with Avant adapters. The use of the third party attachments with Avant adapters A36433, A434684, A434804, A437407, A437144, A435531 and A442082 is done at your own discretion and risk, and with agreement that you will be solely responsible for any personal injuries or material damage.

## Euro adapter

These adapters make it possible to lift and transport attachments with Euro quick attach bracket. Two models available:

- 1) Adapter which is bolted permanently on a Euro attachment. Part no. A434684.
- 2) Adapter with quick locking. Mounts on Avant's attachment coupling plate and is equipped with manually operated spring-loaded locking pins which lock into Euro attachment. Part no. A434804.



A434684



A434804

Model	Product no
Adapter which is bolted permanently on a Euro attachment	A434684
Adapter with quick locking	A434804

220	225	225LPG	313S	320S	320S+	420	423	520	523	525LPG	528	530	R20	R28	R35	630	635	640	735	745	750	755i	760i	860i	e5	e6	

Very compatible
  Compatible
  Incompatible

# Skid steer adapter

There are four adapter plates with different widths available which allow mounting of skid steer loader attachments on Avant.

**New**



A437407 Mini



A437144 MT mount

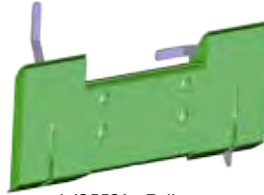

A435531 Full-size

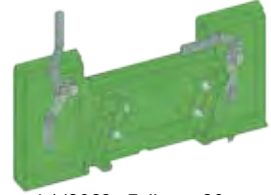

A442082 Full-size 20°

Options

Model	Width	Product no
Mini	584 mm	A437407
MT mount	895 mm	A437144
Full-size	1118 mm	A435531
Full-size 20°*	1118 mm	A442082

\*) increases dumping angle by 20°

220	225	225LPG	313S	320S	320S+	420	423	520	523	525LPG	528	530	R20	R28	R35	630	635	640	735	745	750	755i	760i	860i	e5	e6	



Very compatible



Compatible



Incompatible

# Drawbar

The rigid drawbar is 1000 mm long and equipped with a trailer coupling for 50 mm ball hitch. It mounts on the attachment's quick attach plate and enables towing of the attachment with the loader. This can be useful with certain attachments, like the roller compactor. Height of the drawbar can be adjusted so that it fits on all models; both on Avant 200 series with lower ball hitch and on bigger Avant models. The loader must be equipped with the 50 mm ball hitch.

- **Rigid drawbar, equipped with trailer coupling for 50 mm ball hitch**
- **Mounts on the attachment's quick attach plate – enables towing of the attachment with the loader**
- **Manual height adjustment, for ball hitches on different Avant models**



Length	1000 mm
Weight	25 kg
Product no	A37481

220	225	225LPG	313S	320S	320S+	420	423	520	523	525LPG	528	530	R20	R28	R35	630	635	640	735	745	750	755i	760i	860i	e5	e6	



Very compatible



Compatible



Incompatible



# Hydraulic manifolds to attachment multi connector

There are various hydraulic manifolds with different functions available which mount on the attachment multi connector:

## Flow divider valve

This manifold reduces the auxiliary hydraulics oil flow from the loader to the attachment by 50 %. This means that the attachment movement speed is 50 % slower, which can be useful in situations where a slower attachment speed is required, without reducing loader engine revs too much.

Product no. A421684

## 2-way adjustable pressure relief valve

The pressure relief valve releases the excessive pressure which can be generated in the attachment if it is mishandled by e. g. pulling it too much with the loader. The opening pressure of the relief valve can be adjusted. It controls both the pressure from the loader to the attachment and the pressure in the attachment. In addition, there is a third, feed/tank line which is useful when the attachment is equipped with hydraulic cylinder(s).

Product no. A422104

## Pressure gauges

The hydraulic pressures in the attachment, in both lines, are easy to check with these two pressure gauges. They mount on the A422104 2-way adjustable pressure relief valve. A422104 is not included.

Product no. A422475

## Double check valve

The double check valve is a lock valve which prevents the movements of the attachment's hydraulic cylinder, in both directions, when the attachment is not in operation. This can be useful for instance with the log grab when handling delicate objects like kerb stones etc. – the lock valve makes sure that the grab cannot open.

Product no. A422968



# Adapters for mounting of 200 series 1 attachments on 200 series 2, and vice versa

There are five different adapters available, between std. Avant attachment bracket (Avant 200 series 2, manufactured from 2016-) and 200 series 1 (manufactured 2003-2015):

Options

**Case 1:** Adapters with Avant 200 series 1 (216/218/220) attachment bracket:

- 1) Weld-on adapter plate with 200 series 1 attachment bracket A46529
- 2) Adapter A33126 that bolts on std. Avant attachment bracket (adapter colour is grey)
- 3) Adapter A36826 that mounts on std. Avant attachment bracket with quick release pins like the attachment coupling plate of the machine. The 200 series 1 attachment bracket is welded on the other side of the adapter (adapter colour is green). This adapter can be useful when you have several attachments with std. Avant attachment bracket and don't want to mount the A33126 bolt-on adapter on all of them; or when you need to change the attachments often.

For the hydraulic hoses of 200 series 1 attachments you need the A416760 flat face coupling kit. The kit includes 3 pcs flat face quick couplings, their protective caps and the "parking" on the attachment for the attachment hydraulic hoses.

**Case 2:** You have a 200 series 2 machine (Avant 220/225 - or other Avant model with std. Avant attachment coupling plate), and want to mount on it attachments with 200 series 1 attachment bracket. There are two different adapters available:

- 1) Adapter A36825 that bolts on 200 series 1 attachment (adapter colour is grey)
- 2) Adapter A35590 that mounts on 200 series 1 attachment with quick release pin, like the attachment coupling plate of 200 series 1. The std. Avant attachment bracket is welded on the other side (adapter colour is green).

This adapter can be useful when you have several 200 series 1 attachments and don't want to mount the A36825 bolt-on adapter on all of them; or when you need to change the attachments often.

- 3) Adapter A419705 for hydraulic hoses: on multi connector of the machine, to 200 series 1 attachments with flat face couplings



A419705

- 4) A412129 Hose extension kit, 3 pcs, L=800 mm

\* For those 200 series 1 attachments which require longer hoses when mounted on 200 series 2, for example: high tip bucket, mini digger, log grab, auger, lawn mower, collecting mower, all-round grapple 170



A46529



A33126



A36826



A416760

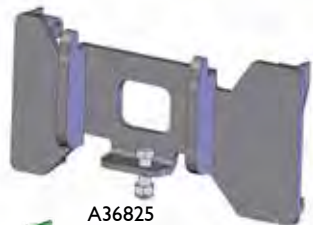

A36825



A35590



A412129

# Filter kits



Product no.	Model
A46682	216
A46683	218 / 220 series I and 2
A420536	225
A44494	Multi 13 hp, Profi 11/13 hp, 313 / 313 S
A44495	Multi diesel/Power diesel/Profi diesel/314, 320, 320+
A45855	314S, 320S, 320S+, manufactured 08/2002 - 10/2004
A46871	314S, 320S, 320S+ manufactured 10 / 2004 - 1 / 2011 serial numbers before XXXXX1104
A414036	320S / 320S+ manufactured 1/2011-, serial numbers after XXXXX1105
A44738	513, manufactured after 06 / 2001
A44493	Multi Plus
A44492	514, 520, 520+, manufactured 2000 - 06 / 2001 serial numbers: 23721 - 24862
A44739	514, 520, 520+, 523+, manufactured 06 / 2001 - 08 / 2002 serial numbers: 24865 - 25933
A45854	514, 520, 520+, 523+, manufactured 08 / 2002 - 10 / 2004 serial numbers: 25935 - 44575
A46870	514, 520, 520+, 523+, manufactured 10/2004 - 12/2007
A414863	419
A49572	420 / 520 series 2, serial numbers before xxxxx1324
A416943	420 / 520 series 2, serial numbers after xxxxx1325
A425525	423 / 523
A414037	525 LPG, manufactured 1 / 2011 -
A46112	528+, manufactured before 06 / 2001, serial numbers: 24325 - 24841
A44740	528+ / 530+, manufactured 06 / 2001 - 08 / 2002, serial numbers: 24852 - 25966
A45853	528+ / 530+, manufactured 08/2002-12/2007, serial numbers: 25967-55601
A48036	528 series 2 (2008-), 530, R28, 630 / 635, serial numbers before XXXXX0902
A417231	R20
A410961	630 / 635 / 640 serial numbers after XXXXX0903, R35
A442098	735
A410784	745 / 750, serial numbers before XXXXX1518
A419900	745 / 750, serial numbers after XXXXX1519
A418900	755i / 760i / 860i

# Wheels & tyres

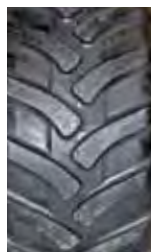

Size	Bolt pattern	Tyre + rim
		Product no:
4.00 x 12	4 x 100	64072
5.00 x 10	4 x 100	63630
5.00 x 10	6 x 100	65412

Size	Bolt pattern	Tyre + rim	Tyre + rim, Solid Foam fill
		Product no:	Product no:
5.70 - 12	5 x 140	A434525	-
23 x 8.50-12	4 x 100	64120	-
23 x 8.50-12	6 x 120	65046	66087
23 x 8.50-12	5 x 140	65995	66089
27 x 8.50-15	6 x 120	65019	66078
27 x 8.50-15	10 x 140	65414	66079

Size	Bolt pattern	Tyre + rim	Tyre + rim, Solid Foam fill
		Product no:	Product no:
20 x 8.00-10*	4 x 100	66231	66379
23 x 10.50-12	4 x 100	64618	-
23 x 10.50-12	6 x 120	65048	66085
23 x 10.50-12	5 x 140	65997	66091
26 x 12.00-12	4 x 100	64752	-
26 x 12.00-12	6 x 120	64931	66082
26 x 12.00-12	10 x 140	65739	66083
320/60-12, HD	6 x 120	65028	-
320/60-12, HD	10 x 140	65224	-
320/55-15	10 x 140	65506	-
400/50-15	10 x 140	65958	-
380/55-17	10 x 140	66505	-

\*) 200 series 2, 2016-



Size	Bolt pattern	Tyre + rim	Tyre + rim, Solid Foam fill
		Product no:	Product no:
18 x 7.50-8	4 x 100	63503	-
20 x 8.00-10	4 x 100	64164	-
20 x 8.00-10*	4 x 100	66252	-
23 x 8.50-12	4 x 100	64160	-
23 x 8.50-12	6 x 120	65045	66086
23 x 8.50-12	5 x 140	65994	66088
23 x 10.50-12	4 x 100	64161	-
23 x 10.50-12	6 x 120	65047	66084
23 x 10.50-12	5 x 140	65996	66090
26 x 12.00-12	4 x 100	64751	-
26 x 12.00-12	6 x 120	64930	66080
26 x 12.00-12	10 x 140	65212	66081
320/55-15	10 x 140	65459	-
380/55-17	10 x 140	A439290	-
400/50-15	10 x 140	66257	-

\*) 200 series 2, 2016-



Size	Bolt pattern	Tyre + rim
		Product no:
26.5 x 14.00-12	6 x 120	65786
26.5 x 14.00-12	10 x 140	65787



Requires 40 mm spacers (5 bolt) on wheel hubs  
when mounted on 500 and 600 series:

- Spacer kit, 4 pcs A418958  
(part no. for one spacer A417486)

# Avant Shop

## Workwear:

Avant Shop



### Work jacket

High quality black Avant work jacket. 70 % polyester, 30 % cotton  
 Sizes S-3XL. 65194

### Winter jacket

Warm and durable winter work jacket with lining. 70 % polyester, 30 % cotton, Thinsulate insulation  
 Sizes S-3XL. 65623



### Work trousers

Black Avant stretch work trousers. Very durable and breathable material.  
 Sizes 46-64.  
 65195



### Winter work trousers

Warm and durable trousers. 70% polyester, 30% cotton.  
 Sizes 46-64.  
 65624



### Coverall, adults

Practical coverall with green details.  
 Sizes S-3XL. 64953

## Leisurewear:



### T-shirt men

Black men's T-shirt with Avant logo.  
 Sizes S-4XL.  
 66540



### T-shirt women

High quality shirt for women, with Avant logo.  
 Sizes XS-XL.  
 66529



### T-shirt adults

T-shirt with Avant loader picture.  
 Sizes S-3XL.  
 66542



### UNISEX-sweatshirt

Black Unisex style adults' sweatshirt.  
 Sizes S-3XL.  
 66531



### Avant fleece

Stylish Avant fleece. 100% polyester.  
 Sizes S-3XL.  
 65561



### Winter jacket, softshell, men

Warm Avant winter jacket, black/grey.  
 Sizes S-3XL.  
 66537



### Beanie

Warm Avant beanie with leather patch.  
 Black 66538  
 Grey 66539



### Baseball cap

Stylish baseball cap.  
 Black regular A436054  
 Grey snapback A436053

# Avant Shop

## Children's wear:



**Children's T-shirt, black**  
Funny T-shirt for children.  
Sizes 92 cm - 164 cm.  
66530



**Children's brake socks**  
High quality children's  
brake socks.  
Sizes 19-27.  
66534



**Children's summer coverall**  
Practical children's sum-  
mer coverall with yellow  
details.  
Sizes 90-160.  
64953



**Children's winter coverall**  
Durable children's winter  
coverall for hard use.  
Sizes 90-160.  
66536

Avant Shop

## Other:



**Backpack, black**  
High-quality backpack, with  
zipped pockets and side  
straps.  
64949



**Avant bottle**  
Aluminium bottle,  
volume 750 ml  
A436002



**Popsocket**  
Practical phone acces-  
sory, improves grip when  
handling the phone.  
With Avant loader picture A436003  
With Avant logo A436004



**Pacifier**  
BPA-free Avant pacifier  
for the youngest family  
members.  
65625



**Memory game**  
For the whole family.  
Includes 36 pairs of cards and  
rules.  
66374



**Avant scale model 1:25**  
Avant 600 series die cast scale model, with  
telescopic boom. Comes with two attachments:  
general bucket and pallet fork.  
66027

# Multi Connector System



Multi connector  
Pressure-Return  
65251



Multi connector  
Pressure-Tank line  
65371



Multi connector  
Pressure-Return-Tank line  
65250



Multi connector  
Loader side  
A34366



Adapter: Multi connector to  
conventional quick couplings  
A414508



Adapter cable for attachment's  
multi connector  
A36679

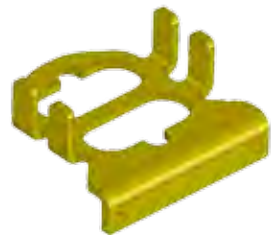

Multi connector  
Parking on attachment  
A418927

# AVANT<sup>®</sup>

AVANT Tecno OY  
Ylotie 1  
33470 YLOJARVI  
FINLAND

Tel. +358 3 347 8800  
sales@avanttecno.com



AVANT has a policy of continuing improvement,  
and retains the right to change specifications without notice.  
© 2020 AVANT Tecno Oy. All rights reserved.

[www.avanttecno.com](http://www.avanttecno.com)